

# MPF-IP

EXPERIMENT MANUAL  
(SOFTWARE/HARDWARE)

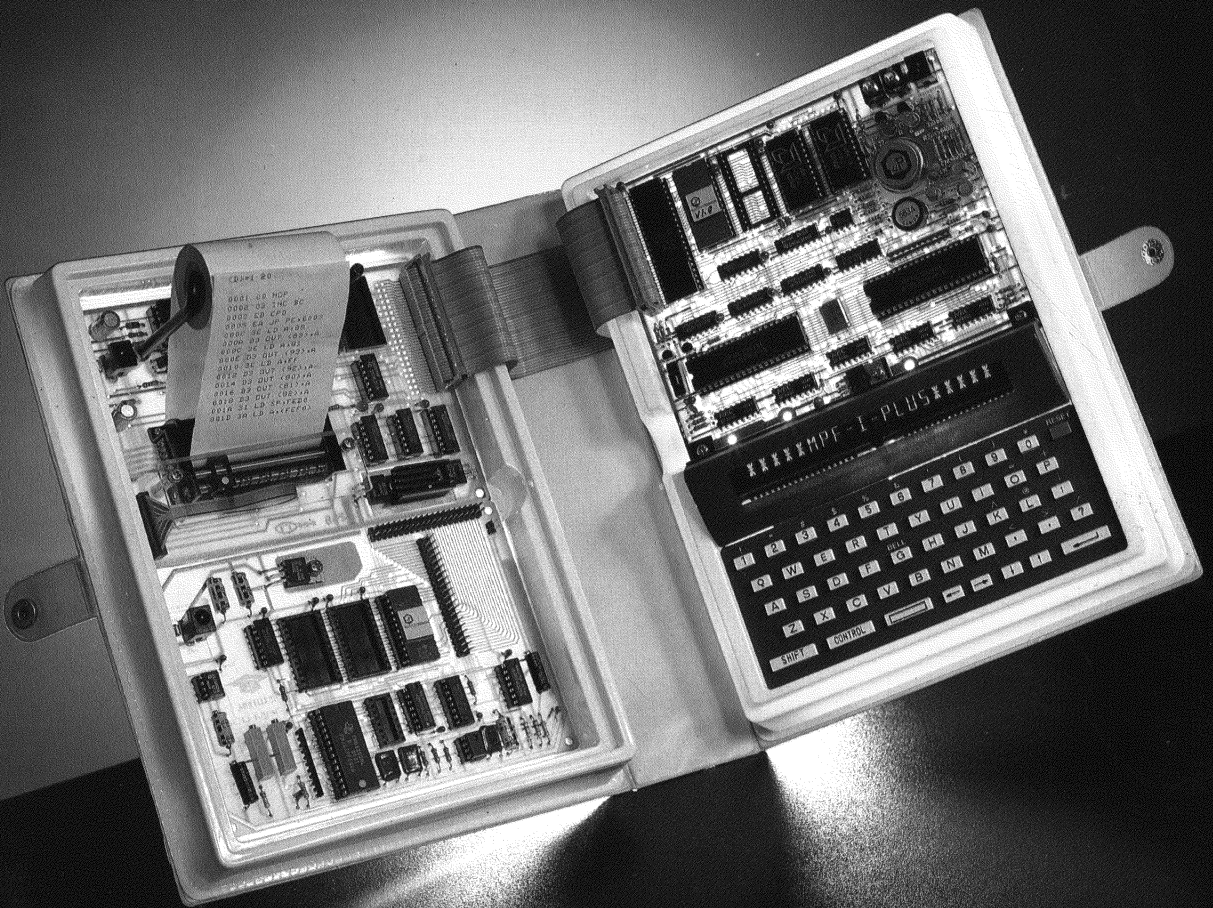



**CHR. M.T.S. MARINUS A. POTTER**  
**Postbus 40413**  
**2504 LK 's-GRAVENHAGE**



# **MPF-IP**

**EXPERIMENT MANUAL  
(SOFTWARE/HARDWARE)**

## COPYRIGHT

Copyright © 1983 by MULTITECH INDUSTRIAL CORP. All rights reserved. No part of this publication may be reproduced, transmitted, transcribed, stored in a retrieval system, or translated into any language or computer language, in any form or by any means, electronic, mechanical, magnetic, optical, chemical, manual or otherwise, without the prior written permission of MULTITECH INDUSTRIAL CORP.

## DISCLAIMER

MULTITECH INDUSTRIAL CORP. makes no representations or warranties, either express or implied, with respect to the contents hereof and specifically disclaims any warranties or merchantability or fitness for any particular purpose. MULTITECH INDUSTRIAL CORP. software described in this manual is sold or licensed "as is". Should the programs prove defective following their purchase, the buyer (and not MULTITECH INDUSTRIAL CORP., its distributor, or its dealer) assumes the entire cost of all necessary servicing, repair, and any incidental or consequential damages resulting from any defect in the software. Further, MULTITECH INDUSTRIAL CORP. reserves the right to revise this publication and to make changes from time to time in the content hereof without obligation of MULTITECH INDUSTRIAL CORP. to notify any person of such revision or changes.



**Multitech**  
INDUSTRIAL CORP.

OFFICE /  
9FL, 286 SUNG CHIANG ROAD, TAIPEI 104,  
TAIWAN, R.O.C.  
TEL: (02)551-1101  
TELEX: 19162 MULTIC FAX: (02)542-2806  
FACTORY /  
1 INDUSTRYE. ROAD, III,  
HSINCHU SCIENCE-BASED INDUSTRIAL PARK,  
HSINCHU, TAIWAN 300, R.O.C.







# MPF-IP EXPERIMENT MANUAL

## TABLE OF CONTENTS

Preparations	
Introduction To Designing Microcomputer Programs	
Experiment 1 Data-Transfer Experiment .....	1
Experiment 2 Basic Applications of Arithmetic and Logic Operation Instructions .....	5
Experiment 3 Binary Addition and Subtraction .....	12
Experiment 4 Branch Instructions and Program Loops .....	23
Experiment 5 Stack and Subroutines .....	30
Experiment 6 Rotate, Shift Instructions, and Multiplication Routines .....	36
Experiment 7 Binary Division Routine .....	42
Experiment 8 Binary-to-BCD Conversion Program .....	48
Experiment 9 BCD-to-Binary Conversion Program .....	52
Experiment 10 Square-Root Program .....	58
Experiment 11 Introduction to MPF-IP Display .....	65
Experiment 12 Fire-Loop Game .....	71
Experiment 13 Stop-Watch .....	76
Experiment 14 Designing a Clock Using Software .....	80
Experiment 15 Telephone Tone Simulation .....	87
Experiment 16 Microcomputer Organ .....	91
Experiment 17 Music Box Simulation .....	96



Preparations :

### Introduction to Designing Microcomputer Programs

A computer program is an organized series of instructions. The central processing unit will perform a series of logical actions to obtain the desired result.

Before a program is executed by CPU it must be stored in memory in binary form. This type of program is called a "machine language program". This is the only type of language the computer understands. The machine language program is usually represented by Hexadecimal digits. For example, the 8-bit instruction 1010 1111B ( B represents binary ) in the Z80 CPU it can be replaced by 0AFH ( H represents hexadecimal). Interpreting a machine language program is extremely difficult and time consuming for the user. the microprocessor manufacturer divides the CPU instructions into several categories according to their functions. The CPU instructions and registers are usually represented by symbols called "mnemonics". For example, the Z80 CPU instruction 70H can be represented by the mnemonic code LD A,L (Load Data into register A from register L). A program written in mnemonic codes is called an "assembly language program." Before an assembly language program can be executed by the CPU, it must be translated into machine language by a special software program called an "Assembler".

Normally a program is written in assembly language. The main advantage of assembly language program over machine language programming is that assembly language programming is much faster to code, the mnemonics makes it much easier for the user to remember the instruction set, and normally the assembler will contain a self-diagnostic package for debugging programs. The main disadvantage of assembly language programs is that it requires an assembler and microcomputer development system. these two items are very costly. With the MPF-IP microcomputer the user has to translate assembly programs into machine level programs by hand before executing programs.

## A. Problem Analysis

The software program of a simple problem may be easily designed with a well-defined flowchart. It may also be obtained by revising some existing programs or combining some simple routines. The design of a more complicated programs, such as monitor programs, system control programs or a special purpose program, are usually started after some detailed analysis of the problem has been made. Problem analysis and solution requires a good understanding of the following:

See page (III-3)

- ( 1) Characteristic and requirements of the problem
- ( 2) Conditions which are known
- ( 3) Input information format and how it is converted
- ( 4) Output data format and how it is converted
- ( 5) Type of data and how precise it is
- ( 6) Execution speed required
- ( 7) CPU instructions and performance
- ( 8) Memory size
- ( 9) The possibility that the problem can be solved
- (10) Methods to solve the problem
- (11) Evaluation of the program
- (12) How the resultant program will be disposed

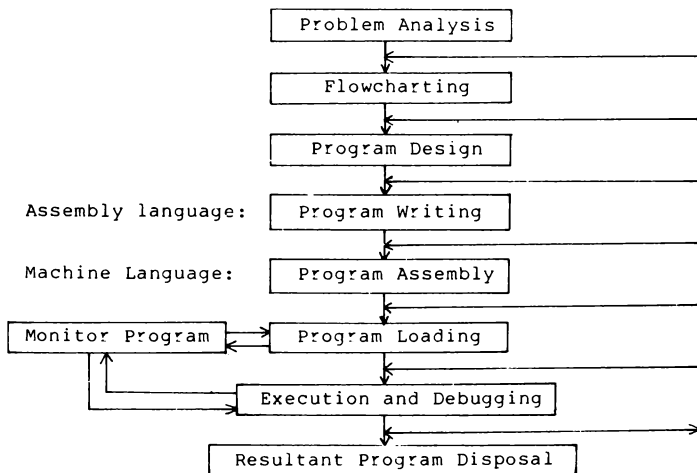

Figure A-1

## B. Flowchart

A flowchart can be used to indicate the behavior of algorithms by suitable graphs. Once the complete flowchart has been completed, a full picture of the programmer's thought processes in reaching a solution to the problem may be followed. Flowcharts are especially important in program-debugging. It is an important part of the finished program. It may help other people to understand the exact algorithm used by the programmer.

Two levels of flowcharts are often desirable:

System flowchart -- showing the general flow of the program

Detailed flowchart -- providing details that are of interest mainly to the programmer.

Usually, a complicated program is introduced using a system flowchart outlining the program, and then a detailed flowchart is presented. The advantage of a flowchart is that it emphasizes the sequential nature of steps by using arrows pointing from each step to its successor. Various symbols are used to indicate the operation that is to be performed at each step. Figure 2-A-2 gives some standard symbols used in flowcharts:

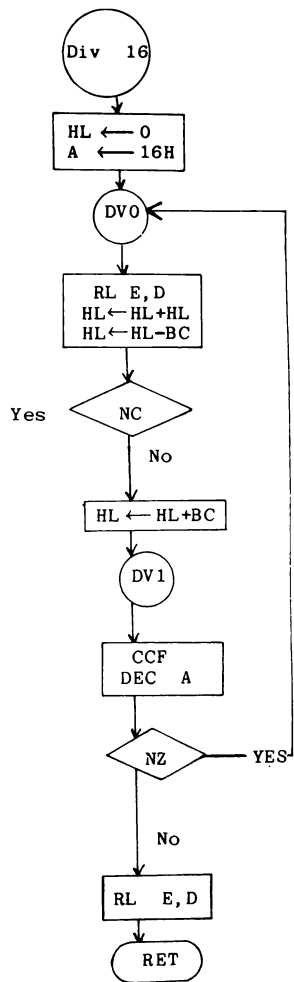
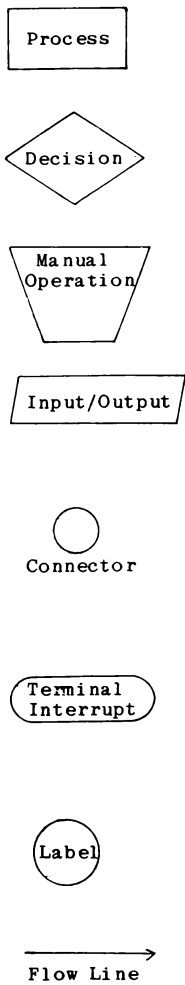

Figure A-2

### C. Program Design

There are many types of programs. Programs for mathematical equations, conversion of input and output signals, coding and decoding of the program data, peripheral device drives, etc. are example of simple programs. Assembler, monitor and system control programs or special purpose applications are examples of more complicated programs. The following items are usually considered in program design:

- (1) Acquisition of input signals or data
- (2) Generation or conversion of output signals and data
- (3) Logical analysis and calculations in the main program
- (4) Relation between the main program and subroutines
- (5) Use of internal registers
- (6) Memory allocation of the main program
- (7) Memory allocation of subroutines
- (8) Memory allocation of data tables and indexed addressing methods
- (9) System initialization and constants in the program
- (10) Definition of the variables in the program
- (11) Consideration of timing sequences and program execution speed
- (12) Limitations of memory size
- (13) Length and precision of data
- (14) Availability of documents and references
- (15) Other special items

## D. Program Writing

In this book, the programs are written mainly in assembly language. Here only the format of the assembly language program is given.

A statement in the program is composed of four parts : Label, Opcode, Operand and Comment. An example is shown below

LABEL	OPCODE & OPERAND	COMMENT
-----	-----	-----
DTB4	LD B,16	
DB3	SRL H	
	RR L	
	RR D	
	RR E	; ROTATE HL DE RIGHT
	LD A,H	
	CALL DB1	
	LD H,A	; CORRECT H
	LD A,L	
	CALL DB4	
	LD L,A	; BINARY CORRECT L
	DJNZ DB3	
	RET	
BINARY CORRECT ROUTINE		
DB4	BIT 7,A	
	JR Z,DB1	; IF BIT 7 OF A = 1, SUB FROM 30H
	SUB 30H	
DB1	BIT 3,A	
	JR Z,DB2	; IF BIT 3 OF A = 1, SUB FROM 03H
	SUB 3	
DB2	RET	

Sometimes, a program statement without a comment is not easy to understand. The comments in the statements are very important especially for a complicated program. Statements with a label and comment field are more convenient for calling and debugging.



## E. Program Assembly

Using the resident assembler in a microcomputer system is an effective way to assemble the source program. However, a beginner or a program designer not familiar with the microcomputer development system must assemble his/her program by hand. The usual procedure for hand assembly is:

- (1) Translate each instruction (mnemonic) into the machine code by looking it up in the conversion table. The comment field of each statement is ignored.
- (2) After deciding the starting address of the program. Assign an appropriate address to the first byte of each instruction. The exact number of bytes needed must be reserved including space for instructions such as JR, DJNZ, and destination addresses of instructions JP, CALL, etc.
- (3) Calculate the relative displacement and put it in the assembled program. A simple formula for calculating the relative displacement is:

$$\text{displacement} = (\text{destination address}) - (\text{next instruction address})$$

If the calculated result is positive, then it is the desired value. If the calculated result is negative, then subtract the result from 100H (i.e. take its 2's complement) and the final result is taken as the operand of this instruction. For instance, in the program listed above, the instruction DJNZ DB3 at address 0014H is first translated into 10xx and then the xx value is calculated.

$$\begin{aligned} \text{xx} &= 0002\text{H} (\text{destination address}) - 1016\text{H} (\text{next instruction's address}) \\ &= -14\text{H} (\text{negative value}) \\ \text{xx} &= 100\text{H} - 14\text{H} = 0\text{E}\text{H} \end{aligned}$$

Therefore, the instruction DJNZ DB3 must be translated into 10EC. In addition, the instruction JR Z, DB 1 at address 0019H is first translated into 28xx, and then the xx value is calculated.

$$\begin{aligned} \text{xx} &= 001\text{D}\text{H} (\text{destination address}) - 001\text{B}\text{H} (\text{next instruction's address}) \\ &= 2\text{H} \end{aligned}$$

The instruction JR Z, DB 1 must be translated into 2802.

The translated machine language is given below:

Address	Machine Language	Label	Opcode	Operand	Comment
					; ** 4 DIGIT BCD TO BINARY CONVERSION ROUTINE **
					; EXTRY : BCD DATA IN HL
					; EXIT : BINARY DATA IN DE
					; REGISTER CHANGED : AF BC DE HL
0000	0610	DTB4	LD	B,16	; B = BIT COUNT
0002	CB3C	DB3	SRL	H	

```

0004    CB1D          RR      L
0006    CB1A          RR      D
0008    CB1B          RR      E      ; ROTATE HL DE RIGHT
000A    7C            LD      A,H
000B    CD1D00       CALL   DB1
000E    67            LD      H,A      ; CORRECT H
000F    7D            LD      A,L
0010    CD1700       CALL   DB4
0013    6F            LD      L,A      ; BINARY CORRECT L
0014    10EC         DJNZ   DB3
0016    C9            RET

;
; BINARY CORRECT ROUTINE
0017    CB7F          DB4     BIT      7,A
0019    2802          JR      Z,DB1    ; IF BIT 7 OF A = 1, SUB FROM 30H
001B    D630          SUB     30H
001D    CB5F          DB1     BIT      3,A
001F    2802          JR      Z,DB2    ; IF BIT 3 OF A = 1, SUB FROM 03H
0021    D603          SUB     3
0023    C9            DB2     RET

```

# Experiment 1

## Data-Transfer Experiment

Purposes:

1. To familiarize the user with the function of data-transfer instruction
2. To practise setting the initial value of data
3. To practise assembling, loading and executing a program

Time required: 4 hours

### I. Theoretical Background:

1. Most of the data-transfer operation is accomplished by using LD (load) instructions. Data can be transferred in group of 8 bits or 16 bits. Also, instructions such as EX, EXX, PUSH and POP can be used to transfer 16-bit data. Instructions such as LDI and LDIR can be used to transfer blocks of data by moving a series of bytes.
2. A LD instruction must have two operands. The first operand represents the location where data will be stored (register or memory section). This is called its "destination". The second operand represents the original location of the data to be transferred. This is called the "source". For instance, LD A,B indicates that data in register B will be transferred to register A. Register A is the "destination" and Register B is the "source".
3. Data transfer instructions can be used in the following ways:
  - (1) register ← register e.g. LD A,B ; LD HL,BC
  - (2) register ← memory e.g. LD A,(HL) ; POP AF
  - (3) register ← immediate data e.g. LD A,25H ; LD HL,125AH
  - (4) memory ← register e.g. LD (HL),A ; PUSH BC
  - (5) memory ← memory e.g. LDD ; LDIR
  - (6) memory ← immediate data e.g. LD (HL),5BH

### II. Experiment 1-1

Write an assembly language program to set the contents of the registers as follows : A=0, B=1, C=2, D=3, E=4, H=5, L=6 (use 8-bit LD instruction to transfer one byte of data each time).

- Step 1 Write the assembly language program in the following blank form. The last instruction is RST 38H which returns control of the MPF-IP to the monitor program after executing the whole program.
- Step 2 Key in the source program using the text editor or input machine code directly to the MPF-IP.
- Step 3 Use the two-pass assembler to assemble the source code to machine code without modifying the default values. Then key in G F B 0 0 and  to execute the program.
- Step 4 Examine the contents in the A, B, C, D, E, H, L registers. If the values are not stored properly, repeat from step 1.

\* Table --- from Chinese MPF-IP Manual p.12

<u>Memory Address</u>	<u>Machine Language</u>	<u>Assembly Language</u>
<u>1800H</u>	<u>3E00</u>	<u>LD A,0</u>
	<u>FF</u>	<u>RST 38H</u>

### III. Experiment 1-2

Write an assembly language program to set the contents of registers as follows: B=12, C=34, D=56, E=78, H=9, L=A (use 16-bit LD instruction to transfer two bytes of data each time).

- Step 1 Same as the step 1 in Experiment 1-1.
- Step 2 Same as the step 2 in Experiment 1-1.
- Step 3 Press G F B 0 0 and  to execute the program.
- Step 4 Use the v key to check contents of each register.

Note

A 16-bit data is composed of two bytes of data. The high-order byte is stored in the higher ordered memory address and the low-order byte is stored in the lower ordered memory address. For instance, the 16-bit data 1234H is stored in addresses 1820H - 1821H in the following way:

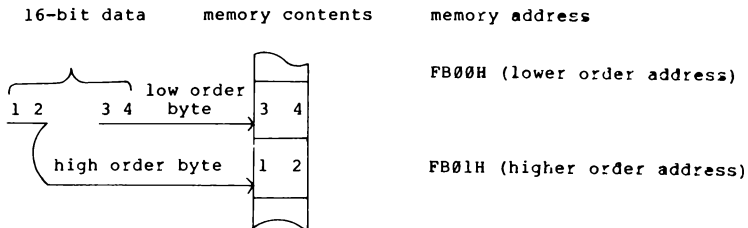

Address	Machine Language	Assembly Language
-----	-----	-----
FB00H	013412	LD BC,1234H
FB01H	FF	RST 38H

Example 1-1 : THE USE OF A LOOP

Write a program to clear the contents of memory addresses FA00H - FA1FH.

Explanation:

- (1) If we use an 8-bit LD instruction to transfer the data to each destination, the single load instruction would be executed for 32 (20H) times. It is more convenient to use the loop method in the program.
- (2) Use register B is generally used as a loop counter. Set register B to 20H before the loop is executed. Use HL as a memory address pointer, and set the starting address FA00H to HL. HL is incremented by one and B is decremented by one for each loop. If B=0, then all loops have been executed; otherwise, run the loop again.

(3) The program is given below:

Address	Machine Language	Label	Opcode & Operand	Comment
F800			LD B,20H	; Set loop counter equal to 32
			LD HL,0FA00H	; Set HL equal to the starting address
			XOR A	; of memory to be cleared
				; Set A=0
		LOOP	LD (HL),A	; Load 0 into the memory address
				; pointed to by HL
			INC HL	; Increment HL by 1
			DEC B	; Decrement HL by 1
			JR NZ,LOOP	; If B not = 0, return to LOOP
FF			RST 30H	; Return to the monitor program

#### IV. Experiment 1-3

Enter the program in the Example 1-1, assemble the source code to machine code, execute the program. Then check if the contents of the memory range from FA00H through FA1FH has been cleared.

#### V. Experiment 1-4 :

Write an assembly language program to set the contents of memory address FA50H - FA7FH as follows: 0, 1, 2, 3, .....F.

(HINT: Change the loop counter and the value of the starting address. register A is incremented by '1' in the next loop)

ADDRESS	MACHINE LANGUAGE	LABEL	OPCODE & OPERAND
-----	-----	-----	-----
-----	-----	-----	-----
-----	-----	-----	-----
-----	-----	-----	-----
-----	-----	-----	-----
-----	-----	-----	-----

# Experiment 2

## Basic Applications of Arithmetic and Logic Operation Instructions

Purposes:

1. To familiarize the user with the arithmetic and logic operation instructions
2. To understand the memory addressing modes
3. To understand the meaning of the register status flag
4. To practise arranging data for CPU registers and memory sections

Time Required: 4 hours

I. Theoretical Background:

1. 8-bit arithmetic and logic operation instructions:

The 8-bit arithmetic and logic operations in the Z80 CPU are performed in register A (accumulator). Registers A, B, C, D, E, H, and L can be used as operands in conjunction with register A in the LD instructions. If data are transferred between memory and register A, the memory address can be pointed to by HL, IX or IY registers. The meaning of the following instructions are given in the right-side comment field:

- (1) ADD A ; Data in register A is added to itself, i.e. the data is doubled shifted left one bit.
- (2) ADC B ; Register B and the carry flag are added to register A.
- (3) SUB C ; Data in register C is subtracted from register A.
- (4) SBC (HL) ; Subtract the data in the memory address pointed to by HL and the contents of the carry flag from register A.
- (5) AND D ; Logical "AND" of register D and register A.
- (6) OR 0FH ; Logical "OR" of data 0FH and register A .
- (7) XOR A ; Exclusive "OR" register A and itself. (Since register A is equal to register A, the result is zero).

- (8) INC H ; Increment the contents of register H by 1.
- (9) INC (IX) ; Increment the contents of the memory address pointed to by register IX by 1.
- (10) DEC C ; Decrement the contents of register C by 1.
- (11) DEC (IY+3) ; The sum of the contents of register IY and 3 is used as the memory address pointer. Decrement the contents of memory address IY +3.

## 2. Data Addressing Mode

In the above assembly language instructions, the addressing modes used can be summarized below. Other addressing modes can be found in the Z80 CPU technical manual.

### (1) Register Addressing

Example:

In the instruction ADC A,B, ADC is the opcode which represents what kind of operation will be performed. The character A in the right means that the data will be added to A. The character B at the far right means that the data to be added to A is taken from register B.

### (2) Register Indirect Addressing

A 16-bit register is used to store the memory address.

Example: In the instruction SBC A,(HL) , (HL) does not mean that HL will be subtracted from register A. Instead, the CPU takes the 16-bit data contained in HL as the memory address and then accesses the 8-bit data stored in this memory address. The 8-bit data pointed to by HL is finally subtracted from register A. IX and IY are called index registers. When a memory address is pointed to by IX or IY, an 8-bit byte which is less than +127 but larger than -128 can be added to this register.

For instance, the following two instructions can be used to add the data stored in the memory address pointed to by IX to the 8-bit data stored in the memory address pointed to by IX+2. The result is stored in register A.

```
LD    A,(IX)
ADD   A,(IX+2)
```



### (3) Immediate Addressing

Example : OR 0FH. On the right-hand side of the opcode OR, a hexadecimal number, 0FH, is given. It means that the number 0FH is logically ORed with the contents of register A. Therefore, the data is part of the instruction which is stored in memory. The CPU fetches the data by using the program counter (PC) as a reference address. The following instructions are examples of immediate addressing.

```
LD      B,8
ADD     A,44H
SUB     A,0A4H
```

### 3. Status Flags

After a logical or arithmetic operation is finished, the result will be stored in register A and some of the status flags (Carry, Overflow, Change Sign, Zero Result, Parity) will also be affected. These status flags will be stored in the flip flops in the Z-80 CPU. These flip flops form a register called the Flag Register. The data in this register can be moved to memory, like data in other registers, by specific instructions (PUSH instruction). Some of the status flags are given below.

#### (1) Carry Flag

This flag is the carry from highest order bit of the Accumulator. The carry flag will be set in either a signed or unsigned addition where the result is larger than an 8-bit number. This flag is also set if a borrow is generated during a subtraction instruction. The carry flag can be used as a condition for jump, call, or return instructions. The carry flag also serves as an important linkage in multi-byte arithmetic operations. Three 8-bit data can be connected as a 24-bit data by using carry flag and four 8-bit data can be connected as a 32-bit data.

#### (2) Overflow/Parity Flag

When signed two's complement arithmetic operations are performed, this flag represents overflow. The Z-80 overflow flag indicates that the signed two's complement number in the accumulator has exceeded the maximum possible (+127) or is less than minimum possible (-128).

When an arithmetic operation is performed in the Z80-CPU, the number in register A can be assumed to be unsigned data (0 - 255) or signed data (-128 - +127). Thus, either the carry flag or the overflow flag can be affected by the arithmetic operation. The programmer decides which interpretation is desired. The following arithmetic operations are described on the right-hand side.

<pre>       10101100     +) 11101000     ----- 1 &lt;- 10010100           </pre>	<p>&lt;- unsigned number 172 or signed number -84</p> <p>&lt;- unsigned number 232 or signed number -24</p> <p>&lt;- unsigned number 148 with carry or signed number -108 but no overflow</p>
<pre>       01001010     +) 01000010     ----- 0 &lt;- 10001100           </pre>	<p>&lt;- signed or unsigned number 74</p> <p>&lt;- signed or unsigned number 66</p> <p>&lt;- unsigned number 140 but no carry, or signed number -116 but overflow has occurred and the result becomes negative</p>

change sign

For logical operations in the Z80-CPU, this flag is set if the parity of the 8-bit result in the accumulator is even. This flag is very useful in checking for parity errors occurring during data transmission. Since carry and overflow will never occur in logical operations, the parity and overflow status can be stored in the same flip flop. This flip flop is called the P/V flag. By testing this flip flop the programmer can check overflow after arithmetic operations and check parity after logical operations.

### (3) Zero Flag

If register A is zero after a logical or arithmetic operation, this status will be registered in a flip flop called zero flag. The zero flag can be used as a condition for branch instructions. It is very useful in program looping.

### (4) Sign Flag

If the leftmost bit (bit 7) of register A is 1 after a logical or arithmetic operation, the number in register A is interpreted as a negative number. The sign flag is then set to 1. This flag will be ignored if the programmer has assigned the data as unsigned numbers.

- (5) The other flags designed for BCD arithmetic are not important for the programmer. The bit positions of the flags discussed above are shown below:

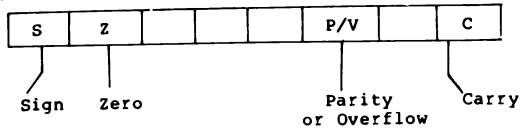

In microcomputers, it is usual to represent the contents of the flag register by two hexadecimal digits. The reader has to express this two-digit data with an 8-bit binary number. By referring to the bit positions in the flag register, the reader can obtain the status of the flag. For instance, if the flag register is 3CH, then the sign is positive, the value is non-zero, the parity is even or there is overflow has occurred but there is no carry. To know which flags will be affected by an instruction, the reader has to refer to the assembly language manual. Not all instructions will affect the status flags.

## II. Example of Experiments

- The following program can be used to add the contents of register D and register E together. The result will be stored in the register pair HL. Load the program into MPF-IP and then execute it. Record the result.

```

ORG      0FB00H ; Starting Address <- 0FB00H
LD       A,E   ; A <- E
ADD      A,D   ; A <- A + D
LD       L,A   ; L <- A
LD       A,0   ; A <- 0
ADC      A,0   ; A <- A + 0 + Carry
LD       H,A   ; H <- A
RST     38H   ; Return to Monitor

```

Preset Value		Result of Program Execution				
Register		Register	Flag			
D	E	HL	Sign	Zero	P/V	Carry
5AH	A6H					
46H	77H					

2. The following program can be used to add the 16-bit data in memory addresses FA00H - FA01H to the 16-bit value in the register pair DE. The result will be stored in the register pair HL. Load the program into MPF-IP and execute it. Discuss the result obtained.

Preset values of memory: (FA01H) = \_\_\_\_\_, (FA00H) = \_\_\_\_\_  
 Preset value of register DE pair = \_\_\_\_\_,

```

ORG      0F800H      ; Starting address <- 0F800H
LD       A,(0FA00H)  ; A <- (FA00H)
ADD      A,E         ; A <- A + E
LD       L,A         ; L <- A
LD       A,(0FA01H)  ; A <- (FA01H)
ADC      A,D         ; A <- A + D + Carry
LD       H,A         ; H <- A
RST     38H         ; Return to monitor.
  
```

Result:

Preset values of memory: (FA01H) = \_\_\_\_\_, (FA00H) = \_\_\_\_\_  
 Preset value of register DE pair = \_\_\_\_\_,  
 result HL = \_\_\_\_\_,  
           Carry = \_\_\_\_\_,  
           Zero = \_\_\_\_\_,  
           Overflow = \_\_\_\_\_,  
           Sign = \_\_\_\_\_.

3. Revise the above program for a subtraction operation.
4. The following program can be used to add the 32-bit data in memory addresses 0FA00H - 0FA03H to the 32-bit data in memory addresses FA04H - 0FA07H. The result will be stored in memory addresses 0FA08H - 0FA0BH. The higher-order byte is stored in a higher address (This is conventional in microcomputer programming)

```

                ORG      0FB00H
                LD       B,4
                LD       IX,0FA00H
LOOP           AND       A
                LD       A,(IX)
                ADC      A,(IX+4)
                LD       (IX+8),A
                INC      IX
                DEC      B
                JP       NZ,LOOP
                RST     38H
  
```

Result of program testing:

Preset memory contents: ( 0FA03H - 0FA00H ) = \_\_\_\_\_

( 0FA07H - FA04H ) = \_\_\_\_\_

results of program execution: ( 0FA0BH - 0FA08H ) = \_\_\_\_\_

Flag Register = \_\_\_\_\_

5. If the instruction ADC A, (IX+4) is replaced by SBC A, (IX+4), then the above program can be used for a subtraction operation. If the instruction DAA is inserted immediately after the ADC or SBC instruction, then the program becomes a program for decimal addition or subtraction. Load the revised program to MPF-IP and test it.

# Experiment 3

## Binary Addition and Subtraction

### Purposes:

1. To understand how an addition or subtraction operation is performed on a microcomputer.
2. To familiarize the reader with software programming techniques.

Time Required: 4 hours

### I. Theoretical Background:

1. In this experiment, we only discuss unsigned binary integer addition and subtraction. For a N-bit binary number, its range is  $\langle 0, 2^N - 1 \rangle$ . For instance, if  $N = 8$ , the range is  $\langle 0, 255 \rangle$ ; if  $N = 16$ , the range is  $\langle 0, 65535 \rangle$ . If the range of the numbers are expressed by hexadecimal digits, the ranges are  $\langle 0, FFH \rangle$  and  $\langle 0, FFFFH \rangle$ , respectively. If the sum of an addition operation is larger than the maximum value that can be represented by N bits, then carry is generated and the carry flag is set. In the subtraction operation, if the subtrahend is more than the minuend, a borrow is generated and the carry flag is set in the high order byte. The set carry bit indicates an incorrect result.

### Example 3-1:

Single byte addition and subtraction.

Addition:  $7FH + ADH = 12CH$

```
      01111111 -> 7FH
+)  10101101 -> ADH
-----
      100101100 -> 12CH
```

Carry

Subtraction:  $7FH - ADH$

```
      01111111
-)  10101101
-----
      111010010
```

Subtraction:  $ADH - 7FH = 2EH$

```
      10101101
-)  01111111
-----
      000101110
```

Borrow  
The answer is incorrect  
( CY = 1 )

Borrow  
The answer is correct  
( CY = 0 )

Example 3-2

Three-byte addition and subtraction

Addition: 6A7CBDH + 4B65ACH = B5E269H

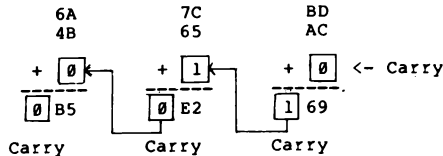

Subtraction: 854372H - 69ACBFH =

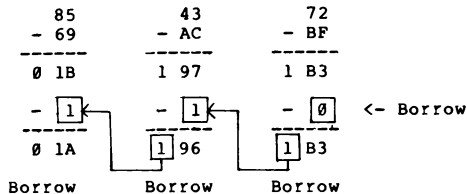

The borrow of the highest-order byte is 0, thus the answer is correct. In multi-byte subtraction, the correctness of the result depends upon the borrow of the highest-order byte. If the borrow is 1, then the result is incorrect.

2. Order of data stored in memory:

The conventional way of storing multi-byte data in memory is: the lowest order byte is stored in the lowest address and the highest order byte is stored in the highest address. The address of the multi-byte data is usually expressed by its lowest address. For beginning at stance, the number 7325H is stored beginning at memory address A in the following way:

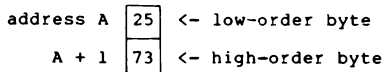

If the starting address of 4 three-byte numbers stored in memory is A, the data and their addresses can be shown as follows :

Address	A		
		56	} 987C56H
		7C	
		98	
	A + 3	43	} AD6943H
		69	
		AD	
	A + 6	BC	} 2501BCH
		01	
		25	
	A + 9	78	} 439578H
		95	
		43	
	A + 12	21	} .....
		96	

### 3. Design of Addition/Subtraction Programs:

The data used in addition/subtraction operation are stored in memory according to the conventional method given above. The starting address of the augend/minuend is stored in index register IX. The starting address of addend/subtrahend is stored in index register IY. The byte-number of the data is stored in register B. First, clear CY and load the augend/minuend into the accumulator. Then, use the indexed addressing mode instruction ADC ( SBC ) to proceed with the addition/subtraction operation. The result is stored in the original address of the augend/minuend. Increment the index registers and compare register B with zero. Repeat the load augend, add, store increment cycle until the B register equals zero. Finally, test the carry flag to check if the result is correct. The only difference between the addition program and subtraction program is that the instruction ADC is used for addition operation and the instruction SBC is used for subtraction operation. The flowcharts and programs are given below for comparison:



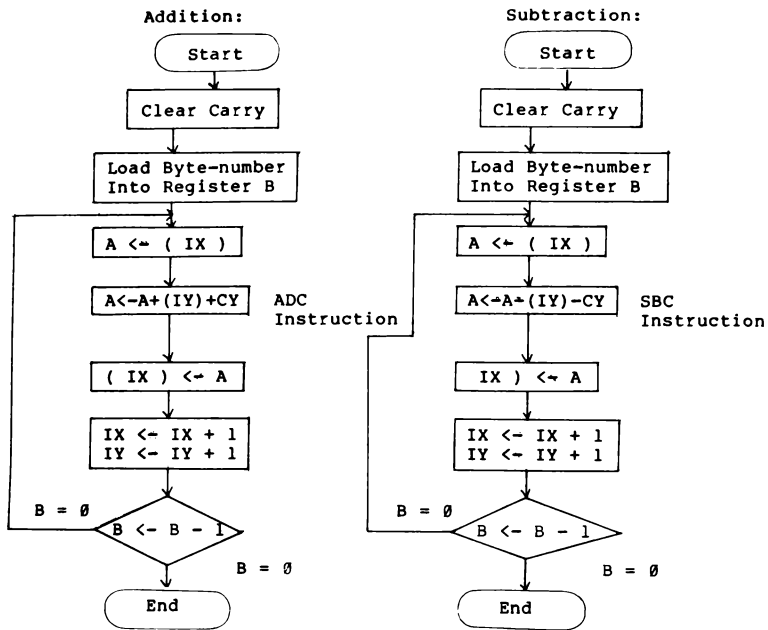

The following block diagram is given to demonstrate data transfer in an addition operation.

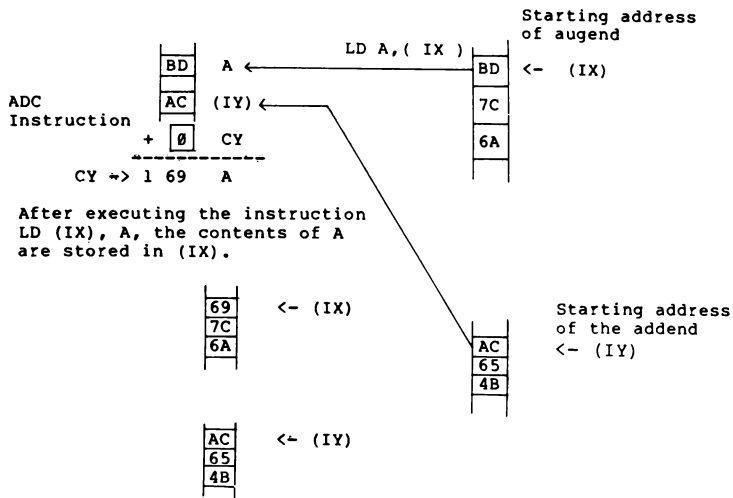

Instruction INC IX increases the value of IX by one.  
 In the comment field the incrementation of IX can be shown as IX IX + 1  
 INC IY leads to IY ← IY + 1

In each of frames showing the results of an instruction step the current value pointed to by the index registers are indicated by

index register

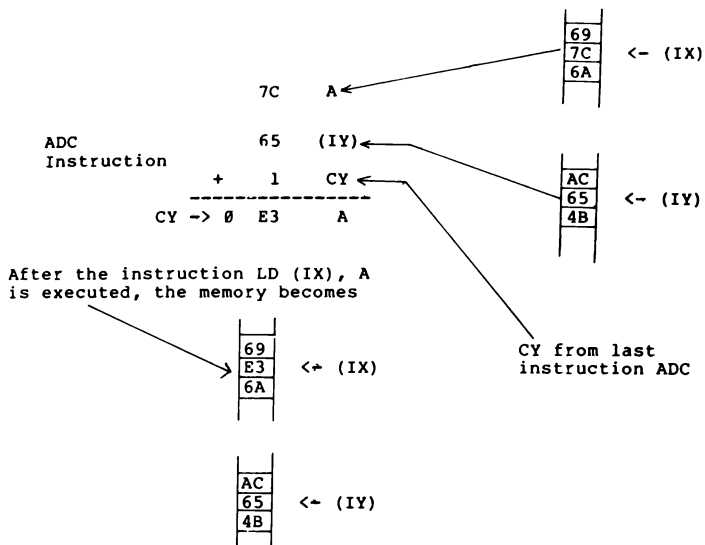

When B = 0, the program execution is completed and the memory becomes

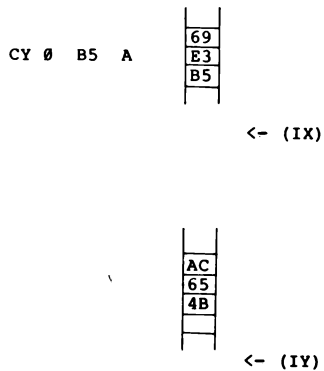

The addition program is given below. By replacing the instruction ADC A, (IY) by SBC A, (IY), the addition program becomes a subtraction program.

```
1. *** MPF-IP EXAMPLE PROGRAM ***
2. 3-BYTE ADDITION ( UNSIGNED INTEGER )
3. ENTRY ; AUGEND ADDRESS IN IX,
4.   ADDEND ADDRESS IN IY.
5. EXIT  : SUM IN AUGEND ADDRESS
6.
7. ADD3  : XOR A ; CLEAR CARRY FLAG
8.       LD B, 3 ; BYTE NUMBER IN B
9. ADDLP : LD A, (IX)
10.      ADC A, (IY)
11.      LD (IX), A
12.      INC IX
13.      INC IY
14.      DJNE ADDLP
15.      RET
```

#### 4. Programming Technique:

From the above examples (3-1 and 3-2), we can see that the multibyte addition/subtraction operation can be accomplished by repeating the single-byte addition/subtraction operation, that is, by the loop operation of single-byte addition/subtraction. In the above program, register B is used as a loop counter. If the byte-number is 4, then 4 is loaded into B initially. Register B is decremented by 1 after each loop operation. The loop ends when B = 0. The instruction DJNZ is used for conditional jump. When B = 0, the program no longer executes the jump operation. Since ADC and SBC instructions are used in the programs, the CY is included in each addition/subtraction operation. Therefore, before the first byte addition/subtraction operation, the carry flag must be cleared (instruction XOR A). The index registers IX and IY are used as address pointers. By incrementing IX and IY, the CPU can access multibyte values stored in memory.

## II. Student Exercises:

1. Load the above addition program into MPF-IP and store it on magnetic tape.
2. Replace the last instruction RET in the program by RST 38H. Load the following data into memory. The starting addresses of augend and addend are assigned as F900H and FA00H, respectively. Execute the program and record the result in the following table.

Augend	Addend	Answer	Check
793865H	ABCEDFH	CY =	
009543H	AB1236H	CY =	
954717H	003390H	CY =	

3. Replace the ADC instruction by the SBC instruction. Assign the starting addresses of minuend and subtrahend as F900H and FA00H, respectively. Execute the program and record the results obtained.

Minuend	Subtrahend	Answer	Check
683147H	336700H		
5935ABH	5877FFH		
049677H	F65B79H		

4. Express the data in the above two tables as five-byte data. Change the byte-counter to the proper value and execute the addition/subtraction program.
5. Write a program to add the 7-byte data in memory addresses FA00H - FA06H to the 7-byte data in memory addresses F900H - F906H and then subtract the 7-byte data in memory addresses F940H - F946H from the sum. The final result must be stored in memory with the starting address F900H.

#### Experiment 3-1:

The carry/borrow flag is used to indicate whether a carry/borrow is generated during an arithmetic or logical operation. If a carry/borrow is generated, then the flag is set to 1. Otherwise, the flag is zero. The carry flag is represented by bit 0 of the flag register.

REG.F

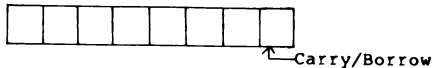

In other words, the contents of the F register will be an even number if a carry/borrow is generated during the arithmetic or logical operation. If register F is an odd number, then no carry/borrow has been generated. Load the following program into MPP-IP. Execute every instruction by using the Single Instruction method. Observe the variations of register F and record the results in the table.

Address	Machine Language		Assembly Language	
FB00H	AF	1	XOR A	A,CY <-- 0
FB01H	3E7F	2	LD A,7FH	A <-- 7FH
FB03H	C6AD	3	ADD 7,ADH	CY,A <-- A + ADH
FB05H	C623	4	ADD A,23H	CY,A <-- A + 23H
FB07H	D613	5	SUB A,13H	CY,A <-- A - 13H
FB09H	D6B3	6	SUB A,B3H	CY,A <-- A - B3H
FB0BH	D615	7	SUB A,15H	CY,A <-- A - 15H
FB0DH	AF	8	XOR A	A,CY <-- 0
FB0EH	3E7F	9	LD A,7FH	A <-- 7FH
FB10H	CEAD	10	ADC A,ADH	CY,A <-- A + A DH + CY
FB12H	CE23	11	ADC A,23H	CY,A <-- A + 23H + CY
FB14H	DE13	12	SBC A,13H	CY,A <-- A - 13H - CY
FB16H	DEB3	13	SBC A,B3H	CY,A <-- A - B3H - CY
FBFBH	DE15	14	SBC A,15H	CY,A <-- A - 15H - CY
FB1AH	76	15	HALT	

INSTRUCTION	(3)	(4)	(5)	(6)	(7)
BEFORE EXECUTION	A 7 F	A □ □	A □ □	A □ □	A □ □
AFTER EXECUTION	+ A D □ □ □ CY A	+ 2 3 □ □ □ CY A	- 1 3 □ □ □ CY A	- B 3 □ □ □ CY A	- 1 5 □ □ □ CY A
	(10)	(11)	(12)	(13)	(14)
	CY □ □	CY □	A □ □	A □ □	A □ □
	A □ □	A □ □	- 1 3	- B 3	- 1 5
	+ A D □ □ □ CY A	+ 2 3 □ □ □ CY A	- CY □ □ □ CY A	- CY □ □ □ CY A	- □ CY □ □ □ CY A

### Experiment 3-2:

Referring to the operation for of 3-byte addition in example 3-2, write a basic addition program using only three kinds of instructions: XOR A, LD A,(nn) and ADD A,(nn). Assume that the memory addresses of the addend, augend and sum are assigned as follows:

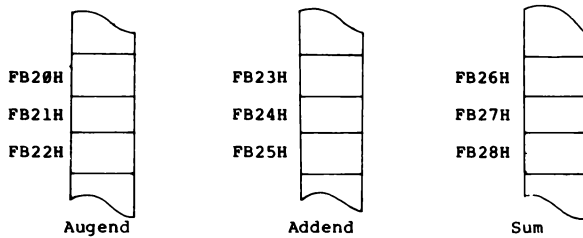

Explanation: In the above example, we see the following rules of addition:

- (1) The addition operation moves from the low-order byte to the high-order byte, the carry generated in the low-order byte addition is added to the next higher order byte.
- (2) The addition operation is executed with the aid of the accumulator. Its result is also stored in the accumulator. Thus to add two bytes together, one byte must be loaded into the accumulator first (using the LD A,(nn<sub>1</sub>) instruction). The other byte is then added to the accumulator (using the ADD A,(nn<sub>2</sub>) instruction or the ADC A,(nn<sub>2</sub>) instruction). The final result is stored in an assigned memory address (using the LD(nn<sub>3</sub>),A instruction).



# Experiment 4

## Branch Instructions and Program Loops

### Purposes:

1. To familiarize the reader with the applications of conditional and unconditional branch instructions.
2. To familiarize the reader with the technique of designing program loops.
3. To practise using status flags in decision-making.

Time Required: 4 hours

### I. Theoretical Background:

#### 1. Program Counter:

The program counter (PC) is an important 16-bit register in the CPU. When the voltage level of the RESET pin (pin 26) of the CPU drops to 0 and then rises to 1 (by pressing the RS key), the PC will be cleared to 0000H. The program execution is then started from address 0000H according to the clock pulses supplied by the system hardware. Once the CPU has fetched one byte of each instruction from memory, the PC will be incremented by one automatically. (The internal control circuit in the CPU determines how many bytes are contained in the instruction after the CPU has fetched the first byte of the instruction. The instruction will be executed only when the PC has been incremented by the number of bytes in the instruction). Usually, the program is fetched from the memory instruction by the instruction for execution, starting from the low memory address.

#### 2. Branch Instructions:

At any address, the PC can be changed to another address if the programmer doesn't want the program execution to continue sequentially (For instance, when there is no memory beyond that address or the program is not stored in that area). The program then jumps to another address and continue its execution. For example, the following assembly language means that the PC will be changed to 1828H after this instruction has been executed, and the program execution continues from address 1828H.

LD PC, 1828H (This instruction is illegal in Z80 assembly language.)

Actually, in assembly language, JP (Jump) is used to indicate the change in sequence of program execution. The instruction has the same meaning as LD PC, F028H

JP F028H

### 3. Conditional Branch Instructions:

A conditional branch instruction performs the jump operation if some specified conditions are met. These conditions are all dependent on the data in the flag register. This function makes the microcomputer capable of responding to various external conditions. It is also an indispensable tool for designing program loops. The actions of the following instructions are described in the comments to the right of the instruction:

```
CP  10H          ; Compare the accumulator with 10H and
                  ; set the proper flag.

JP  Z,  F028H    ; If the zero flag is set, i.e. A = 10H,
                  ; then jump to address F028H and continue
                  ; the program execution.

JP  C,  245AH    ; If the carry flag is set, i.e. A < 10H,
                  ; then jump to 245AH to execute other
                  ; program.

ADD A,B          ; Otherwise, i.e. A > 10, continue the
                  ; program execution.
```

The condition of a conditional branch instruction is written after JP:

- (1) JP C, XXXX ; If there is a carry, or carry flag = 1, then jump to XXXX.
- (2) JP NC, XXXX ; If there is no carry, or carry flag = 0 then jump to XXXX.
- (3) JP Z, XXXX ; If zero flag = 1, or the result of previous operation is zero, then jump to XXXX.
- (4) JP NZ, XXXX ; If zero flag = 0, then jump to XXXX.
- (5) JP PE, XXXX ; If parity flag = 1 (even parity), or there and an overflow in the previous arithmetic operation, then jump to XXXX.
- (6) JP PO, XXXX ; If P/V flag = 0 (odd parity or no overflow) then jump to XXXX.

- (7) JP P, XXXX ; If sign flag = 0 (the sign of result of previous operation is positive) then jump to XXXX.
- (8) JP M, XXXX ; If sign flag = 1 (negative) then jump to XXXX.

#### 4. Jump Relative:

To reduce the memory space occupied by the program and also reduce the cost of the microcomputer system, the Z80 microcomputer can use relative addresses to specify the displacement of a program jump. Since most displacements in a jump are within the range between +127 and -128, a one byte number can be used to indicate this displacement. One byte of memory is saved for each jump operation compared with the two-byte absolute address in JP instructions. The operations of the following instructions are described in the commands to the right of the instruction.

- JR 10H ; Jump forward 10H (16) locations from the present program counter (the address of the next instruction). Actually, the address of the next instruction to be executed is obtained by adding 10H to the present PC.
- JR C,FOH ; If carry flag = 1, then jump backward 10H (16) locations from the present program counter. Since the leftmost bit of FOH is 1, it is recognized as a negative number (its 2's complement is 10H).
- JR NC,7FH ; If carry flag = 0, then jump forward 127 locations (maximum value)
- JR Z,80H ; If zero flag = 1, i.e. the result of the previous operation is zero, then jump backward 128 locations. 80H (-128) is the minimum negative number that can be used in a relative address.

From the above examples, we can see that a positive relative address means jumping forward. The largest displacement then is 7FH (+127). A negative relative address means jumping backward. Its largest displacement is 80H (-128). The displacement is always measured from the address of the next instruction's op code. Relative jumps can be unconditional or conditional. The conditional jump depends on the status of the carry or zero flag. In the Z80 system, the data in the sign or P/V flag cannot be used as the condition of a relative jump.

## 5. Program Loop:

One of the important advantages of a computer is that it can repeat the steps in a repetitive task as many times as is necessary to complete the task. This is accomplished by using a program loop. Looping is a very powerful tool in program design. A basic program loop must contain the following:

- (1) A loop counter preset with the number of loops to be executed. Usually, a CPU register is used as a loop counter. Of course, memory can also be used as a counter.
- (2) The loop counter is decremented by 1 after one cycle of the loop has been executed. After each cycle the value of the loop counter must be checked. If the counter is not 0, then the loop repeats until the loop counter equals 0.

The following program can be used to add the 8-bit data in memory addresses 1900H - 190FH and store the result in the DE register pair. This is a typical application of a program loop.

```
LD C,10H      ; Use register C as the loop counter. Since
               ; sixteen bytes data are to be added together,
               ; 10H is preset in C.

XOR A         ; Clear the accumulator

LD HL,1900H   ; Use the HL register pair as the address pointer.
               ; The contents of the memory pointed to by HL
               ; will be added to register A.
               ; The first address is 1900H.

LD D,A       ; Register D is used to store the carry
               ; generated during the addition operation.
               ; Clear Register D.

XX ADD A,(HL) ; Add the contents of the memory address pointed
               ; to by HL to Register A. This instruction will
               ; be repeated 16 times. XX is assigned
               ; as the label of this instruction's address.

INC HL       ; Increment HL by 1. The new HL points to the
               ; next byte in data memory to be added to
               ; Register A.

JR NC,YY    ; If no carry is generated, jump to address
               ; YY to continue program execution.

INC D       ; If a carry is generated, add this carry to
               ; Register D.
```

```

YY DEC C          ; Decrement register C by 1.

JR NZ,XX         ; If the result is not zero (zero flag = 0),
                 ; the program loop has not finished. Jump to
                 ; XX to repeat the loop.

LD E,A          ; If zero flag = 1, then all data have been
                 ; added together. Load A into E, the answer
                 ; will be stored in the DE register pair.

END

```

There are various methods of designing a program loop. Try to design the program loops described in the following illustrations.

## II. Example Experiments:

1. A program loop with a loop number of less than 256 : If the loop number is less than 256, register B is recommended as the loop counter. At the end of the loop, the DJNZ instruction can be used to decrement register B. If the result is not zero, jump to the assigned location using the relative jump method to continue the program execution. Try to analyze the following program and verify its function by loading it into the MPP-IP and executing it.

```

                                ORG      0F000H
                                LD        HL,0FA00H
                                LD        B,20H
                                →LOOP    LD        (HL),A
                                INC       HL
                                DJNZ     LOOP
                                RST      38H

```

### Experimental result:

- (1) Preset register A to 0 and then execute the above program  
Results:  
Contents of memory addresses F900H - F91FH:  
Contents of memory address F920H:
- (2) Preset register A to 55H and execute the above program.  
Results:
- (3) Preset register A to 64H and replace the second instruction LD B,20H by the instruction LD B,0 . Execute the program again.  
Results:  
Contents of memory addresses F900H - F9FFH:

Discussion:

2. Nested loops:

In a more complicated program, a loop can be totally nested or embedded inside another loop. The following program can be used to divide the 256 bytes of data stored in memory into 19 groups. The starting address of the memory is F900H. Put the contents of each group of data in the form of a hexadecimal number:

0.....(1st set), 1.....(2nd set), 2.....(3rd set),.....F.....  
(19th set).

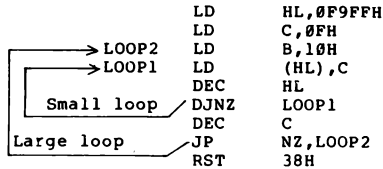

- (1) Translate the above program into machine language and then load it into the MPF-IP. Execute the program.

Results:

- (2) Revise the above program such that the 19 bytes of the first group are all "F", and the 16 bytes of the last group are all "0".

3. A program loop with loop number larger than 256: If the loop number is larger than 256, a 19-bit register can be used as the loop counter. But, in the Z80 system, incrementing or decrementing a 16-bit register can not affect the status flag. Thus, some auxiliary instruction is used to determine whether the loop counter is zero. The following program is supposed to be able to set all data in RAM F980H - FAFH to AAH. Try to find the errors in this program and correct them. Load the correct program into the MPF-IP and record the result of the program execution.

```

                ORG    0F000H
                LD     BC,0180H
                LD     HL,0F980H
LOOP           LD     (HL),0AAH
                INC    HL
                DEC    BC
                JR     NZ,LOOP
                HALT

```

4. A program loop without a down counter : A program loop need not use a down counter. The function of the down counter can be replaced by using an up counter or using the method of address comparison or data comparison. Study the method used in the following program loops. Load the programs into MPF-IP and execute them.

- (1) Move the data string in the memory (RAM) section with starting address FA00H to the memory (RAM) section with starting address F900H. The movement will be terminated when data 0FFH is found.

```

                ORG    0F000H
                LD     HL,0FA00H
                LD     DE,0F900H
LOOP           LD     A,(HL)
                LD     (DE),A
                CP     0FFH
                JR     Z,EXIT
                INC    HL
                INC    DE
                JR     LOOP
EXIT          RST    38H

```

- (2) Replace all the data stored in the memory section starting from the address pointed to by HL to the address pointed to by DE by their corresponding 2's complement. In testing the program, the values of HL and DE must be preset first. The value of HL must be larger than that of DE.

```

                ORG    0F000H
LOOP           LD     A,(HL)
                NEG
                LD     (HL),A
                INC    HL
                AND    A
                SBC    HL,DE
                ADD    HL,DE
                JR     NZ,LOOP

```

# Experiment 5

## Stack and Subroutines

### Purposes:

1. To understand the meaning and applications of the stack.
2. To understand the designing techniques and applications of subroutines.

Time Required: 4 hours

### I. Theoretical Background

1. Stack: In program design, a stack is recognized as a memory section which has only one port for input and output. Data are written in or retrieved from stack via this port. The first data placed in stack is said to be at the bottom of stack. The data most recently placed in stack is said to be at the top of stack. Thus, a stack is also called a last-in first-out memory. A stack can be constructed by hardware shift registers or general RAMs. In the Z80 microcomputer system, the programmer can assign a region of RAM as the stack. To define a stack at the top of RAM, the highest address of RAM is incremented by 1 and then loaded into the stack pointer (SP) in the CPU. The following program and diagrams illustrate the operation of stack.

Instruction Number	Instruction	Comment
(1)	LD SP, 0FEA0H	; Stack pointer is set to 0FEA0H, i.e. the RAM section with address less than or equal to FEA0H is assigned as stack.
(2)	DEC SP	; Decrement SP by 1. Stack pointer is at FE9FH, i.e. at the bottom of stack.
(3)	LD (SP), H	; Load the contents of register H into memory (RAM) address FE9FH.
(4)	DEC SP	; Decrement SP by 1 again.
(5)	LD (SP), L	; Place the contents of L at the top of stack (i.e. above H).
(6)	DEC SP	
(7)	LD (SP), A	; Place the contents of A at the top of stack (i.e. above L).
(8)	DEC SP	
(9)	LD (SP), F	; Place the contents of F at the top of stack (i.e. above A).
	.	
	.	
	.	
	.	



```

(10) LD C, (SP)      ; Pop one byte of data from the top
                    ; of stack and move it to register C.
(11) INC SP          ; Increment SP by 1. SP is moved towards
                    ; the top of the stack.
(12) LD B,(SP)      ; Pop data from the top of stack.
(13) INC SP          ; Increment SP by 1 again.
(14) LD E,(SP)      ; Pop data from the top of stack and
                    ; move it to register E.

(15) INC SP
(16) LD D,(SP)      ; Pop data from the top of stack and
                    ; move it to register D. This data is the
                    ; first one that is stored in stack.
(17) INC SP          ; SP is at the initial value.

```

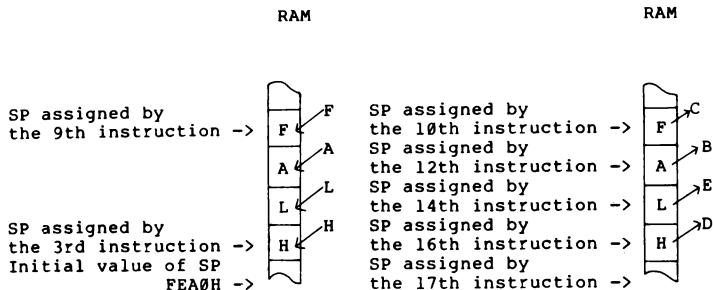

Push data onto the stack

Pop data from the stack

From the above illustrations of stack operation, we can see that data can be stored in RAM by using SP as the pointer. SP is decremented by 1 whenever one-byte of data is stored in and the stack area becomes larger. The SP will be incremented by 1 whenever one-byte data is retrieved from the stack area and the stack area becomes smaller. The process of decrementing SP (pushing data onto stack) or incrementing SP (popping data out of stack) can be accomplished automatically by special hardware design. A stack can also be used to store a 16-bit address (or data). In the Z80/8085 system, there are instructions to push a 16-bit register pair onto stack and pop a 16-bit data out of stack. During each operation, SP is decremented or incremented by 2. The following program is equivalent in function to that of the program given above.

```

LD SP, 0FEA0H ; Same as 1st instruction.
PUSH HL ; Same as no. (2)(3)(4)(5) instructions.
PUSH AF ; Same as no. (6)(7)(8)(9) instructions.
POP BC ; Same as no. (10)(11)(12)(13) instructions.
POP DE ; Same as no. (14)(15)(16)(17) instructions.

```

Instructions PUSH and POP can be used to temporarily store data in registers and also used to transfer register data. An example is given below.

```

PUSH BC
POP IX ; Move the 16-bit data in BC to IX
PUSH HL
AND A
SBC HL,DE ; Compare HL with DE to generate status
; flags. The value of HL is kept
; unchanged.

POP HL

```

It is a very important that the number of PUSH instructions be equal to the number of POP instructions in the stack operation.

## 2. Subroutine:

Programs for arithmetic (addition, subtraction, multiplication or division), keyboard and display control, etc are often used as part of a large program in practical applications. If the programmer rewrites these small programs everytime he needs them, the whole program would be very tedious to write. To save memory space for the program and reduce errors, subroutines are often used in a large program. Instructions CALL and RET are used to manipulate the subroutines. The subroutines can be executed unconditionally or according to the conditions of flags. The instruction CALL in the main program is used to call the subroutine. Its function consists of two operations which are illustrated below.

```

Equivalent to { CALL 0FA38H ; Call the subroutine stored in address 0FA38H.
                { PUSH PC ; Push the current program counter onto
                { JP 0FA38H ; Jump to address FA38H and continue the
                  program execution.

```

RET instruction doesn't need an operand (1 byte instruction), it is the same as 'POP PC' instruction.

Equivalent to	RET	; Return to original program and continue to execute.
	POP PC	; Retrieve 16-bit data in stack and load into PC, then execute program according to PC contents.

Calling a subroutine is an important step in a program. Subroutines in a program can be in a nested form that is a subroutine can be another subroutine. The relationship is shown below:

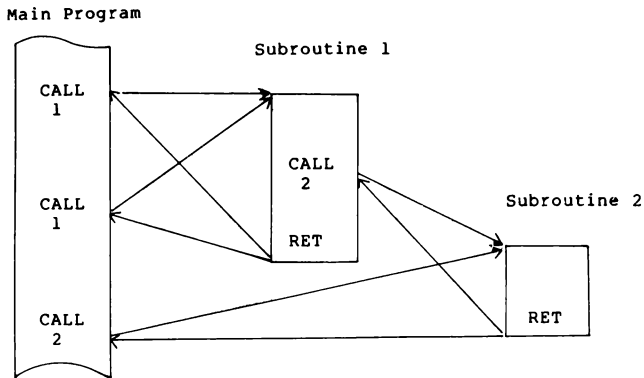

Usually, subroutines are written by a specialist. The user only has to understand its calling procedure. If the subroutine is written by the user himself, the following items must be considered in the design:

- (1) An easily-remembered name must be chosen for the subroutine.
- (2) How to get the data required in the subroutine before executing the subroutine.
- (3) How to express the result after executing the subroutine.
- (4) Which register will be changed after executing the subroutine.
- (5) How much memory will be occupied by the subroutine and how much time is needed for the CPU to execute the subroutine.

The following must also be considered when a subroutine is called by the main program:

- (1) Registers that should not be changed by the execution of the subroutine must be pushed onto stack before calling the subroutine.
- (2) How the results obtained from the subroutine execution will be transmitted by the main routine (the calling routine).

The following listing is a sample subroutine named MADD.  
It can be used for multi-byte BCD addition.

LOC	OBJ CODE	STMT	MADD LISTING SOURCE STATEMENT	PAGE 1 ASM 3.0
		1	; *** MULTIBYTE BCD ADDITION ROUTINE ***	
		2	; ENTRY: HL POINTS TO LOW ORDER BYTE OF AUGEND	
		3	; DE POINTS TO LOW ORDER BYTE OF ADDEND	
		4	; B = BYTE NUMBER, 1 BYTE = 2 BCD DIGIT	
		5	; 'EXIT : IX POINTS TO LOW ORDER BYTE OF RESULT	
		6	; REG. CHANGE : AF,B,HL,DE,IX	
		7	; MEMORY USED : 15 BYTES	
		8		
FB00	AF	9	MADD XOR A ; CLEAR CARRY FLAG	
FB01	1A	10	MADD1 LD A,(DE)	
FB02	86	11	ADD A,(HL)	
FB03	27	12	DAA	
FB04	DD7700	13	LD (IX),A	
FB07	13	14	INC DE	
FB08	23	15	INC HL	
FB09	DD23	16	INC IX	
FB0B	10F4	17	DJNZ MADD1	
FB0D	C9	18	RET	

Two 4-byte BCD data are stored in the memory with starting addresses at 0FA00H and 0FA40H, respectively. To add the BCD data together and store the result in RAM address FA08H, subroutine MADD is called by the following procedure:

```
LD      B, 4           ; Set Byte Number = 4 .
LD      HL, 0FA00H    ; Hl points to the address of augend.
LD      DE, 0FA40H    ; DE points to the address of addend.
LD      IX, 0FA08H    ; IX points to the address of sum.
CALL   MADD
```

## II. Example Experiment:

- (1) Using the instructions for stack operation, write a routine to move the data in HL, DE and BC to HL', BC' and DE', respectively. Load the program into MPF-IP and execute it.
- (2) In the following program, a small loop is embedded in a large loop. The function of this program is to shift all the 8-bit the data in bytes in the address FA1H - FA20H left four bits. Use register B as the loop counter for both small and large loops. Load the program into MPF-IP and execute it. Discuss the reason why register B can be used as the counter for both loops.

F800		1		ORG 0F800H
F800	0621	2		LD B,21H
F802	21001A	3		LD HL,0FA40H
F805	C5	4	LOOP1	PUSH BC
F806	7E	5		LD A,(HL)
F807	0604	6		LD B,4
F809	87	7	LOOP2	ADD A,A
F80A	10FD	8		DJNZ LOOP2
F80C	77	9		LD (HL),A
F80D	23	10		INC HL
F80E	C1	11		POP BC
F80F	10F4	12		DJNZ LOOP1
F811	76	13		HALT

- (3) By calling the subroutine given in part I (multi-byte BCD addition routine), write a program to add two 8-byte data stored in memory FA00H and FA08H. The result must be stored in the 8-byte memory starting at 0FA40H.
- (4) Revise the above program for BCD subtraction or multi-byte binary addition/subtraction. Test the program and record the method of revision used.
- (5) Write a subroutine to change the 16-bit data in HL to its 2's complement. Write a main program to change the data in IX and IY to their 2's complements. Load the program into MPF-IP and test it.
- (6) By using the above routine for complementing the HL register pair, write a program to subtract DE from the data in IY and store the result in IY.

# Experiment 6

## Rotate, Shift Instructions, and Multiplication Routines

### Purposes:

1. To understand the use of Rotate and Shift instructions
2. To understand the designing techniques and uses of a binary multiplication subroutine.

Time Required: 4 - 8 hours

### I. Theoretical Background:

1. The 9-bit data formed by the carry flag and 8-bit data in a register or memory can be shifted one bit left or right by ROTATE or SHIFT instructions. The ROTATE and SHIFT instructions are mainly used for multiplication and division. We multiply a number by rotating and shifting left the bits that constitute a number, while a division operation is done by rotating or shifting right the bits that constitute a number. There are many ways to rotate or shift the bits of a number. So, there are 13 different types of ROTATE and SHIFT instructions. Please refer to the MPF-IP User's Manual, Appendix C. The mnemonic codes of these instructions are described below.
  - (1) If the leftmost character of an instruction is "R", it is a "ROTATE" instruction. Such instructions can be used to rotate the 9-bit data (formed by 8-bit data and carry flag) left or right one bit, e.g. RLCA, RL, RRA, etc.  
If the leftmost character is "S", then it is a "SHIFT" instruction. All the 9-bits of the data are shifted left or right by one bit. The bit shifted out from one side will not be moved in from other side. Examples of such instructions are SAL and SRL.
  - (2) If the second character from the left is "R", it means "shift right" or "rotate right". Instructions RR, SRL, RRCA, etc. are examples.  
If the second character in the left is "L", it means "shift left" or "rotate left". Instructions RL, SLA, RLCA, etc. are the examples.
  - (3) The meaning of the third character is more complicated, but it can be summarized as follows:



In the above calculation, one bit of the multiplier is checked. If that bit is 1, the multiplicand is copied as the partial product. If that bit is 0, 0000 is given instead. The position of the partial product is arranged such that the least significant bit of the multiplicand is aligned with the bit of the multiplier being checked. In this example, multiplicand and multiplier are both 4-bit data. Thus, it is necessary to repeat the operations of checking, shifting and addition four times. Similarly, the operations must be repeated 8 times for 8-bit data multiplication and 16 times for 16-bit data multiplication. In the left-hand side calculation given above, the bit-checking process starts from the least significant bit of the multiplier. In the right-hand side calculation, the bit-checking process starts from the most significant bit. But the results of the two calculations are identical. The program of binary multiplication for microcomputers can be designed by a method similar to the above calculation.

Example: Multiply the 8-bit data in register E by the 8-bit data in register A. The product is stored in the HL register pair.

Answer: Specific registers have been assigned to store multiplicand, multiplier and product according to the characteristics of the Z80 instruction set. Using the calculation algorithm given in the right-hand side of the above example, the program is designed as follows.

1. In the above hand calculation, the bit-checking process starts from the least significant bit. A program loop can be employed in the example. The multiplier is 8-bits long, thus the loop number is equal to 8. In every loop execution, the bit being checked (in register A) can be shifted into the carry flag by the RLCA instruction. Then, according to the condition of the carry flag, we can decide what will (or will not) be done next.
2. If the first bit checked (the leftmost bit) is 1, the partial result is actually obtained by shifting the multiplicand left (n-1) bits, where n is the number of bits in the multiplier. The other partial results are obtained by shifting the partial products left (n-2) bits, (n-3) bits,....., etc. In this example, no other registers are required to store the partial results. Each partial result can be added directly to the HL register pair.
3. From the above description, we can see that the partial products must be shifted left (n-1) bits, (n-2) bits, (n-3) bits,....,etc. Since the bit-checking is also moving left in the process, we can generate a new intermediate result by immediately adding each partial product to the previous intermediate result. This method is more efficient and is used in the following program flowchart.



#### 4. Register Assignments:

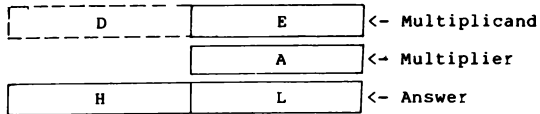

#### 5. Program Flowchart :

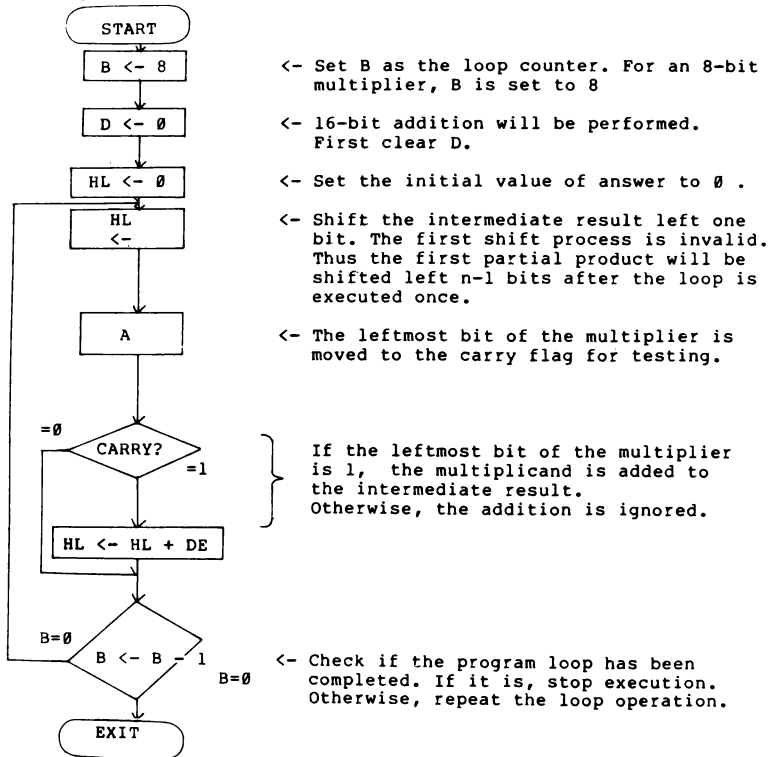

## MP8 LISTING

LOC OBJCODE STMT SOURCE STATEMENT

ASM 3.0

```

1;***MULTIPLY***
2:ENTRY:
3      ;MULTIPLIER IN E
4      ;MULTIPLICAND IN A
5;EXIT:
6      ;PRODUCT IN HL
7;REG  CHANGE   : B,D,HL
8;MEMORY BYTE   : 14
9;EXECUTION TIME :<395 CLOCK / 221.2 uS.
10;
11MP8:
FB00  0608  12MULTI  LD B,8      ;SET BYTE COUNTER=8
FB02  1600  13      LD D,0
FB04  62    14      LD H,D
FB05  6A    15      LD L,D      ;CLEAR D,HL REGISTER
FB06  29    16 LOOP  ADD HL,HL   ;SHIFT HL LEFT
FB07  07    17      RLCA        ;ROTATE BIT 7 OF "A" INTO
                                ;CARRY FLAG
FB08  3001  18      JR NC,NADD    ;TEST CARRY FLAG
FB0A  19    19      ADD HL,DE    ;ADD DE TO HL
FB0B  10F9  20 NADD  DJNZ LOOP    ;END?
FB0D  C9    21      RET

```

## II. Example Experiments:

1. The following program can be used to shift the 32-bit data stored in the HL and DE register pairs, which are adjacent, right one bit (or divide the data by 2). Load the program into MPF-IP and test it. Next, revise the program such that it can be used to shift the 32-bit data left one bit (or multiply it by 2).

```
ORG      0F800H
SRA     H
RR      L
RR      D
RR      E
RST     38H
```

2. Write a program to shift the 32-bit data, stored in RAM addresses FA00H - FA03H, left five bits (or multiply it by 20H). Load the program into MPF-IP and test it. The starting address of the program is assigned as FB00H.
3. Using the RLD instruction, write a program to shift the BCD data, stored in RAM addresses FA00H - FA03H, left four bits. The starting address is assigned as F830H. Load the program into MPF-IP and test it.
4. The following program can be used to multiply the 16 bit data stored in the DE register pair by the contents of register A. Load the program into MPF-IP and test it. Compare this program with the program given in Theoretical Background. Discuss the advantages and disadvantages of this program.

```
MPY8    LD      BC,800H
        LD      H,C
        LD      L,C
M1      ADD     HL,HL
        RLA
        JR      NC,M2
        ADD     HL,DE
        ADC     A,C
M2      DJNE   M1
        RST    38H
```

5. Write a program to multiply the 32-bit data stored in RAM addresses FA00H - FA03H by the 32-bit data stored in RAM addresses FA04H - FA07H. The product must be stored in RAM addresses FA08H - FA0FH.

# Experiment 7

## Binary Division Routine

Purposes:

1. To understand how to write a binary division subroutine for a microcomputer.
2. To familiarize the reader with the technique of software programming.

Time Required: 4 - 8 hours

### I. Theoretical Background:

1. Binary division by hand-calculation:

The following example will be used to illustrate the detailed procedure of binary division.

Divide 11101101 by 00010100

- (1) Write the dividend on the right-hand side, divisor on the left-hand side, and put the quotient above the divisor.

	← Quotient
11101101	← Dividend (237)
00010100	← Divisor (20)

- (2) Shift the dividend and the quotient left one bit.

0	← Quotient (Answer)
11101101	← Dividend
00010100	← Divisor

To compare the dividend and the divisor, place seven zeros after the divisor in the columns beneath the dividend. It can then be seen that the dividend is smaller than the divisor. Therefore put "0" in the position of quotient.

- (3) Continue to test if the dividend is less than the divisor with each shift. If the dividend is still less than the divisor, then put a "0" in the quotient. Otherwise, put a "1" in the quotient and the divisor is subtracted from the dividend. In this example, the dividend and the quotient must be shifted left five bits before a "1" can be put in the quotient. Thus four "0"s and one "1" are put in the quotient in the following way.

00001	← Quotient (when the dividend is larger than the divisor "1" is put in the quotient.
11101101	← Dividend
00010100	← Divisor

- (4) Subtract the divisor from the dividend. The difference becomes the dividend.

00001	← Quotient (Answer)
01001101	← Dividend after subtraction
00010100	← Divisor

- (5) The dividend and the quotient are shifted left two bits, then a "1" is put in the quotient.

0000101	← Quotient (Answer)
01001101	← Dividend
00010100	← Divisor

- (6) Subtract the divisor from the dividend. The difference becomes the dividend.

0000101	← Quotient (Answer)
00100101	← Dividend after subtraction
00010100	← Divisor

- (7) Both dividend and quotient are shifted one bit again. Since the dividend is not less than the divisor, put "1" in the quotient.

00001011	← Quotient (Answer)
00100101	← Dividend
00010100	← Divisor

- (8) Subtract the divisor from the dividend, the remainder is placed in the position of the dividend.

00001011	← Quotient (11)
00010001	← Remainder (17)
00010100	← Divisor

(9) If the remainder is not zero, the division process can be continued, but the result will contain fractions.

## 2. Division Program Design:

For the above algorithm, three memory locations are required to store the dividend, divisor and quotient.

**Example :** Write a program to divide the 16-bit data in the DE register pair by the 16-bit data in the BC register pair. The result (quotient) must be stored in the HL register pair and the remainder in the DE register pair.

**Solution:** The register assignment has been given in the problem description. The HL register pair can be used as the working register for 16-bit arithmetic subtraction. Shift the 16-bit data in DE left one bit to the HL register pair. Compare HL with BC. If HL is not less than BC, then subtract BC from HL and the carry flag is set to 1 automatically. Otherwise, no subtraction operation is performed and the carry flag will be 0. Since the right-most bit of DE is now empty, the carry flag is then moved to this position.

The flowchart and the assembly language program are given below.

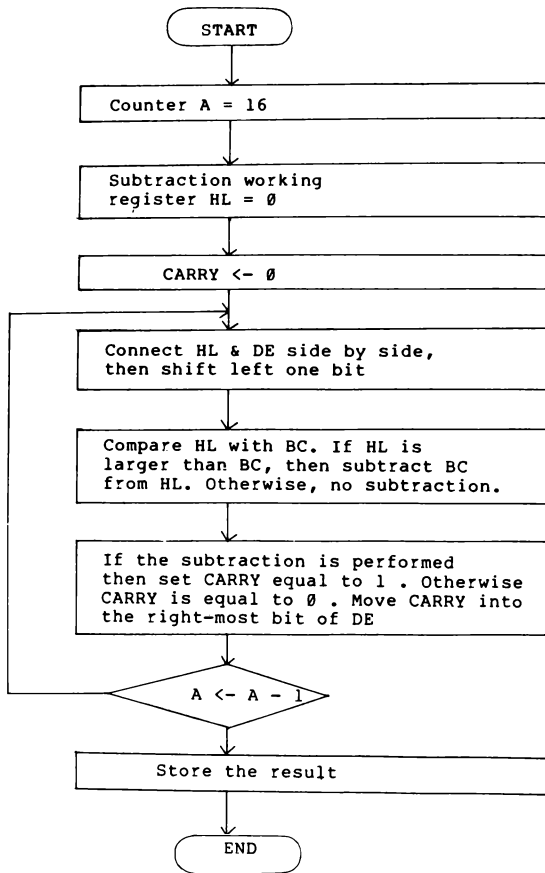

```

1 ; *** MPF-IP EXAMPLE PROGRAM 008 ***
2 ;16 BIT DIVISION ROUTINE
3 ;ENTRY:DIVIDEND IN 'DE'
4 ;      :DIVISOR IN 'BC'
5 ;EXIT :RESULT IN 'HL'
6 ;      :REMAINDER IN 'DE'
7 ;REG. CHANG :AF,DE,HL
8
FB00 AF      9 DIV16 XOR A      ;CLEAR CARRY FLAG
FB01 67     10      LD H,A
FB02 6F     11      LD L,A      ;HL=0
FB03 3E10   12      LD A,16     ;A = 16,LOOP COUNTER
13
14 DV0 ;HL&DE 4 BYTE ROTATE LEFT 1 BIT
FB05 CB13  15      RL E      ;SHIFT LEFT,STORE PARTIAL RESULT
16      IN BIT 0
FB07 CB12  17      RL D
FB09 ED6A  18      ADC HL,HL   ;ROTATE HL LEFT
19
20      IF HL GREAT THAN BC, SUBTRACT FROM BC
FB0B ED42  21      SBC HL, BC  ;HL = HL - BC
FB0D 3001  22      JR NC,DV1
FB0F 09    23      ADD HL,BC   ;IF NEGATIVE,RESTORE HL
24
FB10 3F    25 DV1  CCF      ;PARTIAL RESULT IN CARRY FLAG
FB11 3D    26      DEC A
FB12 20F1  27      JR NZ,DV0
28
FB14 EB    29      EX DE HL
FB15 ED6A  30      ADC HL,HL   ;STORE LAST BIT OF RESULT
FB17 C9    31      RET

```

- (1) Statement 10 and 11 of the program can be replaced by instruction LD HL,0 . But this instruction occupies 3 bytes memory and takes 10 clock cycles to execute. Instead, in this example, LD H,A and LD L,A are used ( A is cleared to zero by statement 9 ). They occupy 2 bytes of memory and can be executed in 8 clock cycles.
- (2) Addition and subtraction instructions can be used for "shift left" or "rotation" operations. In this example, instructions ADC HL,HL is identical with rotating the 16-bit data in HL pair left one bit (The bit moved to the carry flag comes from the leftmost bit of register D). The functions of the following instructions are described on the right-hand side.



```

ADD    A,A    ; Shift register A left one bit;
          or multiply A by 2.

ADC    A,A    ; Rotate A left one bit

ADD    HL,HL  ; Shift HL left one bit; or double it.

ADC    HL,HL  ; Rotate HL left one bit.

ADD    IX,IX  ; Shift IX left one bit; or double it.

ADD    IY,IY  ; Shift IY left one bit; or double it.

```

## II. Illustrations of Experiments :

1. Load the above program into MPF-IP and then store it on audio tape.
2. Replace the last instruction (RET) in the above division subroutine by RST 38H and execute it. Record the obtained results in the following table.

Dividend	Divisor	Answer	Remainder	Check
8686H	0020H			
FFFFH	0003H			
5A48H	0142H			
0H	0142H			
1234H	0H			

3. Modify the above program such that the division process can be continued until a 16-bit fractional quotient is obtained.
4. Using the above program as a subroutine, write a main program to divide the data in RAM addresses FA00H - FA01H by the data in RAM addresses FA04H - FA05H. The result (quotient) must be stored in addresses FA00H - FA01H.
5. Write a program to divide the 4-byte data stored in addresses FA00H - FA03H by the 4-byte data stored in the memory address pointed to by the HL register pair. The result (quotient) must be in addresses FA00H - FA03H. The remainder must be stored in addresses FA04H - FA07H.

# Experiment 8

## Binary-to-BCD Conversion Program

### Purposes:

1. To understand the programming techniques of binary-to-BCD conversion and its applications.
2. To understand the relation between subroutines and the main program.
3. To familiarize the reader with the technique of program writing.

Time Required: 4 hours

### I. Theoretical Background:

#### 1. Methods of binary-to-BCD conversion:

There are several methods for binary-to-BCD conversion. The method given below will be very neat because it uses the DAA instruction. Two memory sections are assigned to store binary and BCD data, respectively. The memory addresses for BCD data are initially cleared to zero. The following process of shifting and checking data is repeated until all binary data bits are shifted left completely: shift the binary data left one bit, and its leftmost bit is automatically transferred to CARRY. The BCD data is then doubled and its rightmost bit-position is filled with the CARRY of binary data. The flowchart will be:

- (1) Preparation:  
Store the binary data in RAM with a starting address of FA00H. Assign register D as the byte counter for the binary data, and register E as byte counter for the BCD data. (Since the bit number of the BCD data may be larger than that of the binary data, the value of E is usually not less than that of D).
- (2) Clear the RAM section (starting address at FA08H) for the BCD data.
- (3) Shift the binary data (stored in RAM with starting address at FA00H) left one bit. The leftmost bit is automatically transferred to CARRY Flag.
- (4) Add CARRY to the BCD data (starting address at FA08H) and then double the BCD data.

(5) Check if all the bits of binary data have been shifted out of the original memory section. If not, repeat step (3). If yes, it is end of the program.

The actual assembly language program is listed below.

				EX001 LISTING	PAGE 1
LOC	OBJ CODE	STMT	SOURCE STATEMENT		
				ASM 3.0	
		1	;*** MPF-IP EXAMPLE PROGRAM 001***		
		2	;MULTIBYTE BINARY TO BCD CONVERSION		
		3	;ENTRY: BINARY DATA STORED IN ADDR. 1A00H		
		4	;EXIT :BCD DATA STORED IN ADDR. 1A08H		
		5	;REGISTER USE		
		6	; D CONTAINS BYTE NUMBER OF BINARY DATA		
		7	; E CONTAINS BYTE NUMBER OF BCD DATA		
		8	; A BCD DATA WORKING REGISTER		
		9	; B LOOP COUNTER		
		10	; C BINARY BIT NUMBER		
		11			
FB00		12	ORG 0FB00H		
		13	BINBCD:		
		14	;CLEAR BCD DATA BUFFER		
FB00	AF	15	CLEAR XOR A ;A=0		
FB01	43	16	LD B,E ; B=BCD BYTE NUMBER		
FB02	21081A	1A	LD HL,1A08H		
FB05	77	18	CLR LD (HL),A ;CLEAR MEMORY		
FB06	23	19	INC HL ;NEXT ADDRESS		
FB07	10FC	20	DJNZ CLR		
		21			
		22	;CALCULATE BIT NUMBER		
FB09	7A	23	LD A,D ;A=BYTE NUMBER		
FB0A	87	24	ADD A,A		
FB0B	87	25	ADD A,A		
FB0C	87	26	ADD A,A ;A=A*8		
FB0D	4F	27	LD C,A ;C=BIT NUMBER		
		28			
		29	LOOP:		
		30	;SHIFT BINARY DATA LEFT		
FB0E	2E00	31	LD L,0 ;HL=1A00=BINARY STARTING ADDRESS		
FB10	42	32	LD B,D		
FB11	CB16	33	SHLB RL (HL)		
FB13	23	34	INC HL		
FB14	18FB	35	DJNZ SHLB		
		36			
		37	;ADD CARRY & DOUBLE BCD DATA		
FB16	2E08	38	LD L 8 ;HL=1A08=BCD STARTING ADDRESS		
FB18	43	39	LD B,E		
FB19	7E	40	BCDADJ LD A, (HL)		
FB1A	8F	41	ADC A,A		
FB1B	27	42	DAA		

FB1C	77	43	LD (HL),A
FB1D	23	44	INC HL
FB1E	10F9	45	DJNZ BCDADJ
		46	
FB20	0D	47	DEC C
FB21	20EB	48	JR NZ,LOOP
FB23	FF	49	RST 38H

## 2. Assembly Language Programming Technique.

(a) Multiply (or divide) a piece of binary data by a fixed number:

Of course, the standard multiplication (or division) subroutine can be used to multiply (or divide) a binary number by a constant. However, a simple multiplication (or division) can be easily accomplished by shifting, additions or subtraction operations. For instance, in the above program, if the byte number of the binary data is known, then the bit number of the data can be easily obtained by multiplying the byte number by 8. In statements 22 - 27, instruction ADD A,A is used three times for multiplying the data in register D by 8 and then storing the result in register C. If the multiplier is not an exponential of 2, then addition or subtraction instructions must also be used.

Example: Multiply the data in D register by 6 and then store the result in register A. The program can be designed as follows.

```
LD      A,D      ; A = D
ADD     A,A      ; A = 2 * D
ADD     A,D      ; A = 3 * D
ADD     A,A      ; A = 6 * D
```

(b) Addressing method for memory on the same page:

A memory address can be pointed to indirectly by a register pair (16 bits). To change a memory address pointed to by a required pair within the same page (each page contains 256 bytes), only a change in the low-order byte of the register pair is required. For instance, in the program listed above, the binary and BCD data are stored on the same page of memory (page 1AH). Since statement 1A assigns the contents of register H as 1AH, only a change in the contents of register L is required to change the pointed address in statements 31 and 38.

## II. Example Experiments:

1. Load the binary-to-BCD conversion program listed in part I into MPF-IP and then store it on audio tape for future applications.
2. Test the above program:

First, store the byte numbers of binary and BCD data in registers D and E, respectively. Next, load the binary data into RAM, with a starting address at FA00H. Record the obtained result and check if it is correct.

Binary	Hexadecimal	BCD	registers D & E
100000000	0200H		D = 2, E = 3
	FFFFH		D = 2, E = 3
	10000H		D = 3, E = 4
	5A48347FH		D = 4, E = 6
	$2^{32}$		D = 8, E = 0AH
	$2^{63}$		D = 8, E = 0AH
	$2^{64} - 1$		D = 8, E = 0AH

3. Change the above program to a subroutine format (Replace the last instruction RST 38H by RET). Using this subroutine, write a program to convert the contents of the DE register pair into a BCD number and then store the converted BCD data in the HL register pair. The contents of the DE register pair will not be changed after the program execution. Test the program and write down the complete program in the blanks below.
4. Write a program to multiply the binary data in register E (<20H) by 7 and store the result in register A.

# Experiment 9

## BCD-to-Binary Conversion Program

Purposes:

1. To understand the methods of BCD-to-Binary conversion.
2. To familiarize the reader with programming technique.

Time Required: 4 - 8 hours

I. Theoretical Background:

1. Methods of BCD-to-Binary conversion:

There are also several method for BCD-to-Binary conversion. In this experiment, the simple yet efficient method of shifting and checking is used. The RAMs used for storing the binary and BCD data are adjacent (in a row with the low-order digit on the right side). The BCD data is stored on the left-hand side and the converted binary data is stored on the right-hand side. The conversion procedure is given as follows.

- (1) Assign the bit number of the binary number as N for N program loops.
- (2) Shift the connected data right one bit.
- (3) Check the left-most bit of each digit (4 bits). If the checked bit is 1, then subtract 3 from the corresponding digit.
- (4) Repeat step (2) & (3) N times. The conversion process is then completed.

2. Principle of the checking process :

The real purpose of steps (2) & (3) of the above method is to divide the BCD number by 2 and put the remainder in the memory. The principle is illustrated in the following figure.

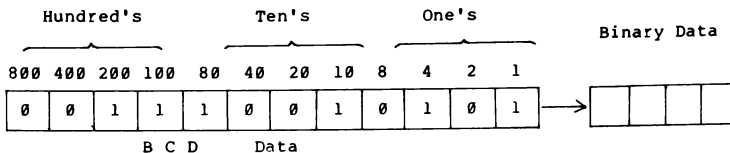

- (1) Each BCD digit contains 4 bits. Shifting the 4 bits of a digit right one bit will divide this digit by 2. For instance, the leftmost digit of the ten's four bits represents 80 if it is "1". If this bit is shifted right, then it represents 40, that is, half of its original value.
- (2) If a "1" is shifted from high a order digit to a lower order digit, the value is reduced to 5 (or 50, 500, ---, etc). However, the resulting BCD code will interpret this bit as 8 (or 80, 800, ---, etc). Thus 3 (or 30, 300, ---, etc) must be subtracted from the resulting BCD number.
- (3) The conversion method can be illustrated by the following hand-calculation.

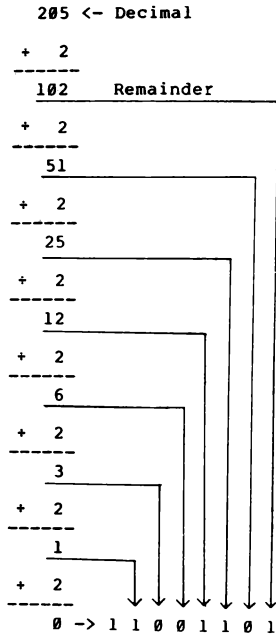

2	205	---	1	BIT 0
2	102	---	0	BIT 1
2	51	---	1	BIT 2
2	25	---	1	BIT 3
2	12	---	0	BIT 4
2	6	---	0	BIT 5
2	3	---	1	BIT 6
	1			BIT 7
	1100	1101		
	C	D		

### 3. BCD-to-Binary conversion program:

Once the conversion method is decided, it is very easy to design the program. The following program can be used to convert 5-byte (or 10-digit) BCD data stored in RAM into 4-byte binary data. Since the largest value of 4-byte binary data is 4,294,967,295, the BCD number to be converted can not exceed this value. In RAM, the memory of addresses FA00H - FA03H are reserved for storing the binary data (lowest-order byte in FA00H). The memory of addresses FA04H - FA08H are assigned to store the BCD data. Sample programs for BCD-to-Binary conversion and Binary-to BCD conversion are listed below for reference.



```

LOC  OBJ CODE STMT SOURCE STATEMENT
      1 ;*** MPF-IP EXAMPLE PROGRAM 007 ***
      2
      3 ; 10 DIGIT BCD TO BINARY CONVERSION
      4 ; ENTRY: BCD DATA IN RAM FA04H TO FA08H
      5 ;       : MAX. BCD DATA IS (4294967295)
      6 ; EXIT : BINARY DATA IN RAM FA00H TO FA03H
      7 ; REG. CHG : AF,HL,BC
FB00   8     ORG FB00H
FB00   9     LD C,32           ;PRESET CONV. LOOP = 32
      10
      11 FB DBLP:
      12 ; DECIMAL DIVID BY 2
      13     LD B,5             ;BCD BYTE COUNT = 5
      14     XOR A             ;CLEAR CARRY FLAG
      15     LD HL,0FA08H     ;HL POINT TO LEFT BYTEL
      16     LD A,(HL)        ;TRANSFER DATA TO A REG.
      17     RRA              ;ROTATE RIGHT
      18     PUSH AF          ;SAVE CARRY FLAG
      19     ;* BCD DIVID CORRECTION
      20     BIT 7,A           ;TEST BIT 7
      21     JR Z,COR1        ;NO CORRECT IF BIT 7 = 0
      22     SUB 30H          ;SUBTRACT FROM 30H IF BIT 7 = 1
      23     BIT 3,A         ;TEST BIT 3
      24     JR Z,COR2
      25     SUB 3
      26     LD (HL),A        ;STORE TO MEMORY
      27     DEC HL            ;NEXT BYTE
      28     POP AF          ;RESTORE CARRY FLAG
      29     DJNZ COR0       ;DONE LOOP
      30
      31 ;ROTATE BINARY RIGHT
      32     LD B,4           ;BINARY BYTE = 4
      33     SHR4            RR (HL)
      34     DEC HL
      35     DJNZ SHR4
      36
      37     DEC C
      38     JR NZ,DBLP
      39     RET

```

LOC	OBJ CODE	STMT	SOURCE STATEMENT	PAGE 2
		40	*E	ASM 3.0
		41	;4 BYTE BINARY TO BCD CONVERSION	
		42	; ENTRY: BINARY DATA STORE IN ADDR. FA00H TO FA03H	
		43	; EXIT :BCD DATA STORE IN ADDR. FA04H TO FA08H	
		44	; REG. CHANG : AF,BC,HL	
		45		
		46	BINBCD:	
		47	;CLEAR BCD DATA BUFFER	
FB27	2104FA	48	LD HL FA04H	
FB2A	0605	49	LD B,5	
FB2C	3600	50	CLEAR LD (HL),0	
FB2E	23	51	INC HL	
FB2F	10FB	52	DJNZ CLEAR	
		53		
FB31	0E20	54	LD C,32	
		55	LOOP	
		56	;SHIFT BINARY DATA LEFT	
FB33	68	57	LD L,B ; HL=FA00=BINARY STARTING ADDRESS	
FB34	0604	58	LD B,4	
FB36	AF	59	XOR A	
FB37	CB16	60	SHLB RL (HL)	
FB39	23	61	INC HL	
FB3A	10FB	62	DJNZ SHLB	
		63		
		64	;ADD CARRY & DOUBLE BCD DATA	
FB3C	0605	65	LD B,5	
FB3E	7E	66	BCDADJ LD A,(HL)	
FB3F	8F	67	ADC A,A	
FB40	27	68	DAA	
FB41	77	69	LD (HL),A	
FB42	23	70	INC HL	
FB43	10F9	71	DJNZ BCDADJ	
		72		
FB45	0D	73	DEC C	
FB46	20EB	74	JR NZ, LOOP	
FB48	C9	75	RET	

0 ASSEMBLY ERRORS

## II. Example Experiments:

1. Load the two subroutines for BCD-to-Binary and Binary-to-BCD conversion into MPF-IP and then store them on audio tape for future application.
2. Replace the last instruction RET of the above subroutines by RST 38H so that control of the microcomputer MPF-IP will be returned to monitor after program execution. Load an arbitrary 5-byte BCD number in RAM address FA04H - FA08H. Convert this BCD data into binary data by using the above program. Check if the result is correct.
3. By a method similar to that described in part I (Theoretical Background), write a program to convert the 4-digit BCD data into binary data: The processing must be held within CPU registers and the result will be stored in the DE register pair.

	Assigned Decimal Number	Converted Binary Number	Re-converted Decimal Number
1			
2			
3			
4			
5			

4. Using the binary multiplication routine and the routines for conversion between binary and BCD data, write a program for decimal multiplication. The decimal multiplier and multiplicand must be stored in the HL and DE register pairs, respectively. The result must be stored in RAM addresses FA04H - FA08H. The data in HL and DE must be unchanged after program execution.

# Experiment 10

## Square-Root Program

### Purposes:

1. To understand how the microcomputer calculates the square root of a binary number.
2. To practice microcomputer programming.

Time Required: 4 - 8 hours

### I. Theoretical Background:

1. Calculating square roots of binary numbers by hand:

There are several methods for calculating the square root of a binary number. The following method for hand-calculation can be easily converted into a microcomputer program. This method is illustrated by calculating the square root of 01010001 (or 81):

- (1) Each of the following blocks represents the position for storing data. The original binary number is stored in Y block, the number 01 is permanently stored in P block. X and R blocks are prestored with 0.

X	Y
	01010001
	01000000
R	P

- (2) Subtract the number formed by the R & P blocks from the number formed by the X and Y blocks. If the result is non-negative, then put 1 at the rightmost position in the R block and shift the original data in the R block left one bit. If the result is negative, then restore the original data in the X & Y blocks and shift the data in R left one bit. In this example, the result of subtraction is positive. Thus, the following result is obtained.

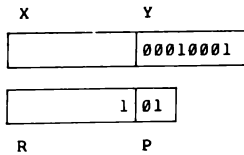

(3) Shift the data in the X & Y blocks left two bits.

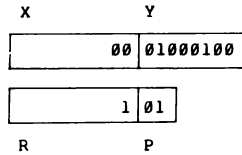

(4) Since the number in the X and Y blocks after the shift process is still less than that in the R and P blocks, thus the data in the R block must be shifted left one bit and a "0" is put in the rightmost position. The data in the X and Y blocks remains unchanged.

(5) Shift the data in the X and Y blocks left two bits.

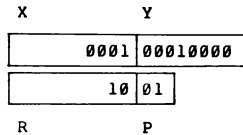

- (6) The new data in the X and Y blocks is still less than the R and P block. Thus, shift the data in the R block left one bit again. An "0" is put in the rightmost position of the R block. The data in the X and Y blocks is also shifted left two bits.

X	Y
000100	01
100	01
R	P

- (7) The number in the X and Y blocks is not less than that in the R and P blocks. Subtract the number in the R and P blocks from the number in the X and Y blocks. Shift the data in R left one bit and put a "1" in the left-most bit-position.

X	Y
000000	00
1001	01
R	P

- (8) Shift data in the X and Y blocks left two bits. Since the original data in the Y blocks has been shifted out completely, the final result is given in the R block.

X	Y
00000000	00
1001	01
R	P

- (9) If the original data in the Y block is not the square root of some integral binary number, then the above method may be continued to find the fractional part of the square root.

## 2. Square root routine

The square root routine can be designed by the method described above. A subroutine for calculating the square root of a 16-bit piece of data is illustrated below.

**Example:** Find the square root of a 16-bit piece of data stored in the BC register pair. The calculation must be continued till the fractional part of the solution contains 8 bits. The integral part of the solution will be stored in register D, while the fractional part will be stored in register E.

**Solution:** The CPU registers are assigned as follows:

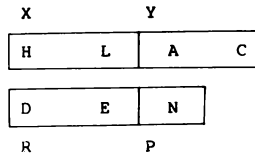

The original data is stored in registers A and C (Y block). The HL register pair is used as the working area of subtraction operation. The answer will be stored in the DE register pair (R block). The data in the P block is a fixed number, its left-most two bits are 01, i.e. the data in the P block may be written as 01000000B (40H). The program and its flowchart are given below.

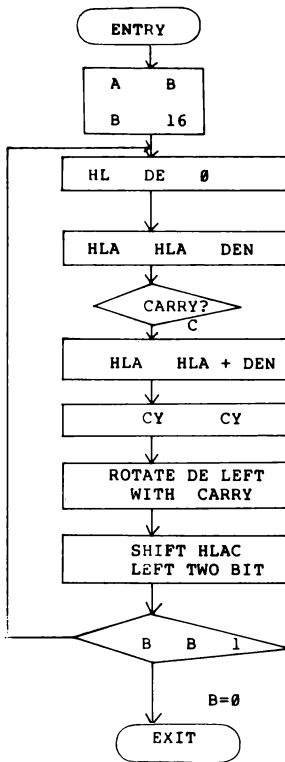



```

1 ; *** MPF-IP EXAMPLE PROGRAM 009 ***
2 ; 16 BIT SQUARE ROOT ROUTINE
3 ;ENTRY: BINARY DATA IN 'BC'
4 ;EXIT : RESULT IN 'D' (INTEGER)
5 ;           'E' (FRACTION)
6 ;REG. CHANG.AF,BC,DE,HL
FB00 78      7 SQRT16 LD A,B           ;A&C = ENTRY DATA
FB01 0610    8      LD B,16         ;LOOP COUNTER
FB03 2100FB  9      LD HL,0         ;HL:WORKING AREA
FB06 54      10     LD D,H
FB07 5C      11     LD E,H         ;DE=0,RESULT PRESET TO 0
FB08 D640   12 SQ0  SUB 40H        ;A=A-40H,40H IS A FIXED DATA
FB0A ED52   13     SBC HL,DE       ;HL=HL-DE
FB0C 3004   14     JR NC,SQ1       ;IS HL > DE ?
FB0E C640   15     ADD A,40H
FB10 ED5A   16     ADC HL,DE       ;IF NOT, RESTORE A&HL
FB12 3F     17 SQ1  CCF            ;PARTIAL RESULT IN CARRY FLAG
FB13 CB13   18     RL E            ;STORE PARTIAL RESULT
FB15 CB12   19     RL D            ; & SHIFT 'DE' (RESULT) LEFT
20     ;'HL.A C' 4 BYTE SHIFT LEFT TWICE
FB17 CB21   21     SLA C
FB19 17     22     RLA
FB1A ED6A   23     ADC HL,HL
FB1C CB21   24     SLA C
FB1E 17     25     RLA
FB1F ED6A   26     ADC HL,HL
27
FB21 10E5   28     DJNZ SQ0        ;DONE LOOP
FB23 C9     29     RET

```

0 ASSEMBLY ERRORS

## II. Example Experiments:

1. Load the above program onto MPF-IP and then store it in audio tape for future applications.
2. Replace the last instruction (RET) by RST 38H. Prestore a 16-bit data in the BC register pair and then execute the square root program. Write down the result obtained.

Data Prestored in BC	Result of Program Execution	Check
0051H		
0000H		
FFFFH		
4000H		

3. Revise the above program such that it can be used for calculating the square root of a 32-bit piece of data. Store the original data in the BC and IX registers. The answer will be stored in the DE register pair. Only the integral part of the square root is required.
4. Using the square root routine and binary multiplication routine, write a program for finding the absolute value of the vector formed by two mutual perpendicular vectors. The length of each vector component can be represented by an 8-bit binary number. These two numbers are stored in the H and L registers, respectively. The result of the program execution will be stored in register D.

$$( D ) = \sqrt{ ( H )^2 + ( L )^2 }$$

# Experiment 11

## Introduction To MPF-IP Display

### Purposes:

1. To understand how to use subroutines of the monitor program for designing display pattern.
2. To understand how the display is designed.
3. To understand the structure and characteristics of a matrix-form keyboard.

Time Required: 4 hours

### I. Theoretical Background:

The structure and the characteristics of the MPF-IP display and keyboard are discussed in detail in Chapter 8 of the MPF-IP User's Manual. In Chapter 5, a number of useful monitor subroutines are listed for users' reference. In this experiment, the sample programs will use some of the monitor subroutines to control the display.

Example 1:

Display 'HELP US' until the SPACE key is pressed. Once the SPACE key is pressed, the CPU will be halted and the red LED lamp will get lighted. The program is shown as below:

```
                                EXP11.1
LOC   OBJ CODE M STMT SOURCE STATEMENT
      1 ;Display 'HELP US', HALT when
      2 ;space key is pressed.
      3 ;
FB00  4          ORG      0FB00H
FB00  210EFB    5          LD      HL,HELP
FB03  CD8608    6          CALL    PRTMES
FB06  CD4602    7  DISP    CALL    SCAN
FB09  FE20      8          CP      20H
FB0B  20F9      9          JR      NZ,DISP
FB0D  76        10         HALT
      11 ;
FB0E  20202020  12  HELP    DEFM    '      '
FB14  48454C50  13         DEFM    'HELP US'
FB1B  0D        14         DEFB    0DH
      15 ;
      16  PRTMES    EQU      0886H
      17  SCAN     EQU      0246H
      18         END
```

## Example 2:

Flash 'HELP US'.

Because the execution time of the SCAN1 subroutine is 15.67 micro-second, to cause the display flashes 'HELP US' and then blank out alternately, the display buffer pointer - IX - should be changed after the SCAN1 has been executed 32 times. The program is as follows:

```
                                EXP11.2
LOC   OBJ CODE M STMT SOURCE STATEMENT

      1 ;Flash 'HELP US':
FB00      2          ORG      0FB00H
FB00   CDB909      3          CALL   CLEAR
FB03   211CFB      4          LD     HL,HELP
FB06   CDCA09      5          CALL   MSG
FB09   DD212CFE    6          LD     IX,DISPBF
FB0D   21D06F      7          LD     HL,BLANK
FB10   E5          8          PUSH  HL
FB11   0620        9   LOOP1  LD     B,32
FB13   CD9B02     10  LOOP2  CALL   SCAN1
FB16   10FB       11          DJNZ  LOOP2
FB18   DDE3       12          EX    (SP),IX
FB1A   18F5       13          JR    LOOP1
      14 ;
FB1C   20202020   15  HELP   DEFM   '      '
FB22   48454C50   16          DEFM   'HELP US'
FB29   0D         17          DEFB   0DH
      18 ;
      19  BLANK   EQU    6FD0H
      20  CLEAR   EQU    09B9H
      21  DISPBF  EQU    0FF2CH
      22  MSG     EQU    09CAH
      23  SCAN1   EQU    029BH
      24          END
```

If you want to change the frequency at which the display flashes, you can achieve that by changing the times SCAN1 is called. If you intend to change the pattern to be displayed, you can alter the operand following the DEFM pseudo-op.

### Example 3:

Display the ASCII code of the key pressed.  
Fill "FF" into each memory location of the memory range from FF2C to FF54, the display will blank out when the program is executed. When a key is pressed, the ASCII code of the key pressed will be displayed. The user may compare it with the ASCII code table provided in the appendix of MPF-IP User's Manual.

```
                                EXP11.3
LOC   OBJ CODE M STMT SOURCE STATEMENT

                                1 ;Display ASCII code:
FB00                                2          ORG      0FB00H
FB00   CDB909                        3          CALL    CLEAR
FB03   DD212CFF                       4 LOOP    LD      IX,DISPBF
FB07   CD4602                          5          CALL    SCAN
FB0A   CDB909                          6          CALL    CLEAR
FB0D   CD9A0A                          7          CALL    HEX2
FB10   18F1                             8          JR      LOOP
                                9          ;
                                10 CLEAR   EQU      09B9H
                                11 DISPBF  EQU      0FF2CH
                                12 HEX2    EQU      0A9AH
                                13 SCAN    EQU      0246H
                                14          END
```

**Example 4:**

Display the position code of the key pressed. When a key is pressed, the position code of the key pressed will be displayed. The user may compare it with the position code table provided in the appendix of MPF-IP User's Manual. The program is as follows:

```

                                EXP11.4
LOC   OBJ CODE M STMT SOURCE STATEMENT

                                1 ;Display position code:
                                2 ;
FB00                                3          ORG      0FB00H
FB00   CDB909                       4          CALL    CLEAR
FB03   DD212CFF                      5          LD      IX,DISPBF
FB07   0603                           6 LOOP1   LD      B,3
FB09   CD9B02                          7 LOOP2   CALL    SCAN1
FB0C   30F9                             8          JR      NC,LOOP1
FB0E   10F9                             9          DJNZ   LOOP2
FB10   CD9B02                          10 LOOP3  CALL    SCAN1
FB13   38FB                             11          JR      C,LOOP3
FB15   CDB909                           12          CALL    CLEAR
FB18   CD9A0A                           13          CALL    HEX2
FB1B   CD9903                           14          CALL    DECSP
FB1E   18E7                             15          JR      LOOP1
                                16 ;
                                17 CLEAR   EQU      09B9H
                                18 DISP    EQU      0FF84H
                                19 DECSP   EQU      0399H
                                20 DISPBF  EQU      0FF2CH
                                21 HEX2    EQU      0A9AH
                                22 SCAN1   EQU      029BH
                                23          END

```

## Exercises

### 1. Example 1:

- (a) If you want to change program in Example 1 so that the MPF-IP will display "HELP US" until the "Q" key is pressed, how will you change the program?
- (b) Try to write a program so that "NESBITT" will be displayed until the carriage return key is pressed. After the carriage return key is pressed, the red LED will get illuminated.

### 2. Example 2:

- (a) Save the program in Example 2 on cassette tape.
- (b) Execute the program and examine the results.
- (c) Change the instruction "LD B,32" to "LD B,50H", and then execute the modified program. Examine the results. Explain why the results of the modified program are different from that of the original program?
- (d) Change the instruction "LD B,32" to "LD B,5", and then execute the modified program. Examine the results.
- (e) Modify the program by changing the contents of the memory so that "HELP US" is displayed for two seconds on the display and then blanked out for two seconds alternately.

### 3. Example 3:

- (a) Save the program in Example 2 on cassette tape.
- (b) Execute the program and examine the results.
- (c) Why does the cursor "▲" appear after the ASCII code? How to eliminate the cursor?

### 4. Example 4:

- (a) Save the program in Example 2 on cassette tape.
- (b) Execute the program and examine the results.
- (c) Why is the displayed position code not followed by the cursor?
- (d) What does the position code mean?  
(You can figure this out by examining the detailed functions of the subroutines SCAN1 and SCAN2.)



# Experiment 12

## Fire-Loop Game

### Purpose:

1. To understand how to use a subroutine contained in the monitor program
2. To familiarize the reader with programming techniques.

Time Required: 4 hours

### I. Theoretical Background:

#### 1. Monitor Program:

After the microcomputer is powered on, it will execute programs from the designated address. Besides some initialization task (e.g. setting 8255 or selecting I/O mode), a special software program called monitor is used to monitor the presence of data or commands from peripheral devices (e.g. a keyboard, an external switch, a button, a sensor, etc.) If no signal is monitored, then the scanning process continues (using the looping method to search) until a signal input is detected. If an input signal is detected, the input signal is then analyzed and the microcomputer jumps to the service routine to perform the job assigned by the input signal. After this service routine has been executed, the microcomputer returns to scan the peripheral devices.

Since MPF-IP is a general-purpose microcomputer, it has a monitor. The main function of this monitor is to respond to key presses on the keyboard and to display necessary data. Tracing the monitor program will improve your programming skill.

2. Fig. 12-1 is the flowchart of the Fire Loop.

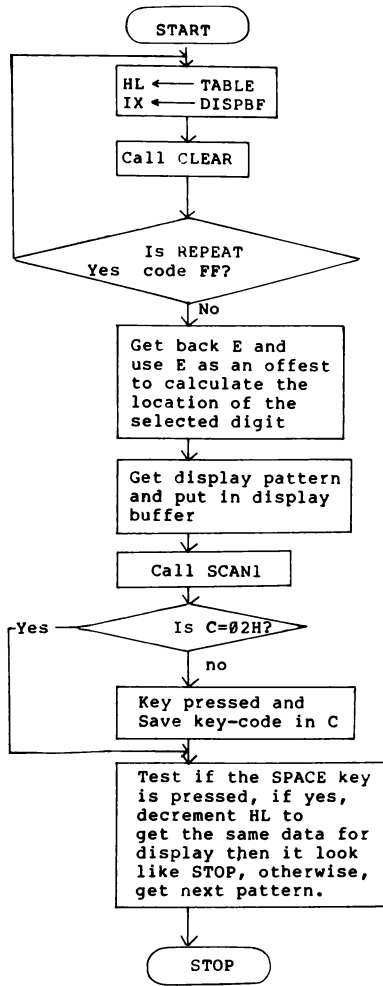

Fig. 12-1 The Flowchart of Fire Loop

LOC	OBJ CODE	M	STMT	SOURCE	STATEMENT	EXPL2	PAGE	1
							ASM	5.9
					1	;		
					2	;Segment illuminates one by one until KEY-SPACE		
					3	;is pressed.Any other key will resume looping		
					4	;again.		
					5	;		
FB00					6	ORG	0FB00H	
FB00	213CFB			7	INI	LD	HL,TABLE	
FB03	DD212CFF			8		LD	IX,DISPBF	
FB07	CDB909			9	LOOP	CALL	CLEAR	;Clear display buffer.
FB0A	5E			10		LD	E,(HL)	;Get the digit-select data.
FB0B	1C			11		INC	E	;Test repeat code:FF.
FB0C	28F2			12		JR	Z,INI	;If yes, go to INI.
FB0E	1D			13		DEC	E	;Otherwise, get back E.
FB0F	7B			14		LD	A,E	
FB10	87			15		ADD	A,A	
FB11	5F			16		LD	E,A	
					17	;The following 9 instructions get display		
					18	;pattern and put into display buffer.		
FB12	1600			19		LD	D,0	
FB14	DD19			20		ADD	IX,DE	
FB16	23			21		INC	HL	
FB17	7E			22		LD	A,(HL)	
FB18	DD7700			23		LD	(IX),A	
FB1B	23			24		INC	HL	
FB1C	DD23			25		INC	IX	
FB1E	7E			26		LD	A,(HL)	
FB1F	DD7700			27		LD	(IX),A	
FB22	DD212CFF			28		LD	IX,DISPBF	
FB26	0603			29		LD	B,SPEED	;Using B registr as SCAN1
					30			;counter.
					31	;The following 4 instructions display the pattern		
					32	;for B times.		
FB28	CD9B02			33	LIGHT	CALL	SCAN1	
FB2B	3801			34		JR	C,NSCAN	
FB2D	4F			35		LD	C,A	;Key pressed, save key code
					36			;in C. Note that, reg C will
					37			;not be changed until next
					38			;key is pressed.
FB2E	10F8			39	NSCAN	DJNZ	LIGHT	
FB30	79			40		LD	A,C	
FB31	FE02			41		CP	02H	;Test KEY-SPACE of SCAN1.
FB33	2803			42		JR	Z,STOP	;If yes, decrement HL to get
					43			;the same pattern for display.
					44			;Then it looks like stop.
					45			;Otherwise, get next pattern.
FB35	23			46		INC	HL	
FB36	23			47		INC	HL	
FB37	23			48		INC	HL	
FB38	2B			49	STOP	DEC	HL	
FB39	2B			50		DEC	HL	
FB3A	18CB			51		JR	LOOP	
					52	;		
					53	CLEAR	EQU	09B9H
					54	DISPBF	EQU	0FF2CH
					55	SCAN1	EQU	029BH
					56	SPEED	EQU	3
					57	;		
FB3C	07			58	TABLE	DEFB	7	;DIGIT 8

LOC	OBJ CODE	M	STMT	SOURCE	STATEMENT	PAGE	2
						ASM	5.9
FB3D	FEFF		59	DEFW	0FFFEH ;SEG a		
FB3F	08		60	DEFB	8 ;DIGIT 9		
FB40	FEFF		61	DEFW	0FFFEH ;SEG a		
FB42	09		62	DEFB	9 ;DIGIT 10		
FB43	FEFF		63	DEFW	0FFFEH ;SEG a		
FB45	0A		64	DEFB	10 ;DIGIT 11		
FB46	FEFF		65	DEFW	0FFFEH ;SEG a		
FB48	0B		66	DEFB	11 ;DIGIT 12		
FB49	FEFF		67	DEFW	0FFFEH ;SEG a		
FB4B	0C		68	DEFB	12 ;DIGIT 13		
FB4C	FEFF		69	DEFW	0FFFEH ;SEG a		
FB4E	0C		70	DEFB	12 ;DIGIT 13		
FB4F	FDFF		71	DEFW	0FFFDH ;SEG b		
FB51	0C		72	DEFB	12 ;DIGIT 13		
FB52	FBFF		73	DEFW	0FFFBH ;SEG c		
FB54	0C		74	DEFB	12 ;DIGIT 13		
FB55	F7FF		75	DEFW	0FFF7H ;SEG d		
FB57	0B		76	DEFB	11 ;DIGIT 12		
FB58	F7FF		77	DEFW	0FFF7H ;SEG g		
FB5A	0A		78	DEFB	10 ;DIGIT 11		
FB5B	F7FF		79	DEFW	0FFF7H ;SEG d		
FB5D	09		80	DEFB	9 ;DIGIT 10		
FB5E	F7FF		81	DEFW	0FFF7H ;SEG d		
FB60	08		82	DEFB	8 ;DIGIT 9		
FB61	F7FF		83	DEFW	0FFF7H ;SEG d		
FB63	07		84	DEFB	7 ;DIGIT 8		
FB64	F7FF		85	DEFW	0FFF7H ;SEG d		
FB66	07		86	DEFB	7 ;DIGIT 8		
FB67	FFFF		87	DEFW	0FFFEH ;SEG e		
FB69	07		88	DEFB	7 ;DIGIT 8		
FB6A	DFFF		89	DEFW	0FFDFH ;SEG f		
FB6C	FF		90	DEFB	0FFH ;REPEAT CODE.		
			91	END			

### 3. Further Experiments

- (a) Load the above program into MPF-IP and then store it on audio tape for future applications. Test this program and record the display response.
- (b) Write a program to make the Fire-Loop illuminate counterclockwise.
- (c) Change the contents of FB32. Then pressing space key will not respond as before. Why?
- (d) Change the contents of FB27 and the display will change. Why?
- (e) Write a program that will cause the segments to move in a pattern of your choice.
- (f) Write a program to display "HELP US" for 20 secs, then play the "Fire-Loop Game" 20 times. Then display "HELP US", and play fire-loop game over and over again.

# Experiment 13

## Stop-Watch

### Purpose:

1. To illustrate how to use monitor subroutines.
2. To practise programming skills.

Time Required: 2 hours

### I. Theoretical Background:

1. The object of this experiment is to design a 2/100 second-based stop-watch. Actually, this is only roughly accurate. The total execution time of the SCAN1 subroutine is 16.184 msec, plus the time required to perform the delay loop, results in the counter to be added by 2 each time all the instructions of the program are executed. The accuracy varies with the system clock and the number of instructions used in the keyboard/display scan subroutine.
2. The demonstration program calls two monitor subroutines SCAN1 and HEX2 which are located at 29BH and 0A9AH respectively.
3. The counting procedure is halted by depressing a key. This is done by checking the result of SCAN1 routine.

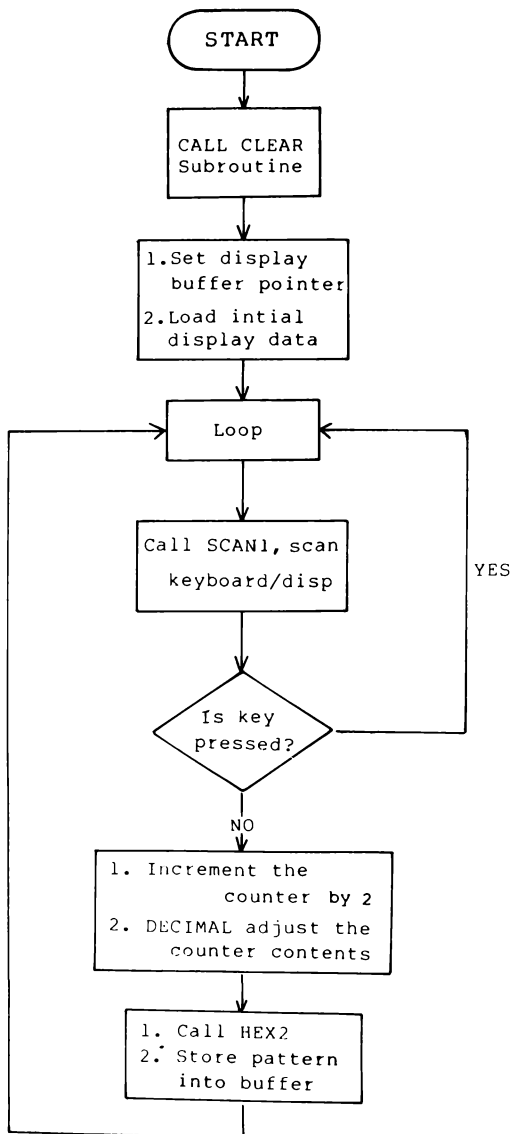

Fig 13-1 Flowchart of stop watch

LOC	OBJ CODE M	STMT	SOURCE	STATEMENT	EXP13	PAGE 1
						ASM 5.9
		1		;STOP-WATCH		
FB00		2		ORG	0FB00H	
FB00	DD212CFF	3		LD	IX,DISPBF	;Initial display pointer.
FB04	0E00	4		LD	C,0	;Initial MIN in C.
FB06	110000	5		LD	DE,0	;Initial SEC & 2/100 SEC
		6				;in DE.
FB09	CD9B02	7	LOOP	CALL	SCAN1	;Display for 15.6 m sec.
FB0C	30FB	8		JR	NC,LOOP	;If any key pressed, then
		9				;looping the same pattern.
		10				;otherwise, increment 2/100
		11				;sec.
FB0E	CDB909	12		CALL	CLEAR	
FB11	7B	13		LD	A,E	
FB12	C602	14		ADD	A,2	
FB14	27	15		DAA		
FB15	5F	16		LD	E,A	
FB16	7A	17		LD	A,D	
FB17	CE00	18		ADC	A,0	
FB19	27	19		DAA		
FB1A	57	20		LD	D,A	
FB1B	D660	21		SUB	60H	;If SEC=60, then set SEC=0 and
		22				;increment MIN by 1.
FB1D	2007	23		JR	NZ,BFUPDT	
FB1F	1600	24		LD	D,0	
FB21	79	25		LD	A,C	
FB22	C601	26		ADD	A,1	
FB24	27	27		DAA		
FB25	4F	28		LD	C,A	
		29	BFUPDT:			
FB26	2138FF	30		LD	HL,DISPBF+12	
FB29	79	31		LD	A,C	;Convert MIN to display
FB2A	CD3BFB	32		CALL	PA	;format, and put them
		33				;into display buffer.
FB2D	7A	34		LD	A,D	;Convert SEC to display
FB2E	CD3BFB	35		CALL	PA	;format, and put them
		36				;into display buffer.
FB31	7B	37		LD	A,E	;Convert 2/100 SEC to dis_
FB32	CD3BFB	38		CALL	PA	;play format, and put them
		39				;into display buffer.
FB35	0601	40	DELAY	LD	B,1	
FB37	10FE	41		DJNZ	\$	
FB39	18CE	42		JR	LOOP	
		43	PA:			
FB3B	2284FF	44		LD	(DISP),HL	
FB3E	CD9A0A	45		CALL	HEX2	
FB41	CD9903	46		CALL	DEC	
FB44	2A84FF	47		LD	HL,(DISP)	
FB47	23	48		INC	HL	
FB48	23	49		INC	HL	
FB49	C9	50		RET		
		51	CLEAR	EQU	09B9H	
		52	DISP	EQU	0FF84H	
		53	DISPBF	EQU	0FF2CH	
		54	DFC	EQU	0399H	
		55	HEX2	EQU	0A9AH	
		56	SCAN1	EQU	029BH	
		57		END		



## II. Illustration of the Experiments

- (1) Load the program and GO!
- (2) Press the **RESET** **CONTROL** and **SHIFT** keys. Watch how the MPF-IP respond? Why?
- (3) Note that the program will loop continuously. How can the execution of the program be interrupted?
- (4) Users are encouraged to modify the program:
  - a. Build a 1/10 second based stop watch.
  - b. Display all zeros at the beginning, start the stop watch by depressing an arbitrary key or the user defined key.
  - c. Build a stop key.
- (5) Check the timing on the display with your watch for one minute. Perhaps, there is an error. Try to find the reasons for the error and note them.

# Experiment 14

## Designing a Clock Using Software

### Purposes:

1. To practise calculating the clock cycle of a program.
2. To construct a software driven digital clock.

Time Required: 4 hours.

### I. Theoretical Background:

1. This is an example of using the software delay to build a digital clock.
2. All the timing is based on the system clock, which is  $3.579545 \text{ MHz} \div 2 = 1.789772 \text{ MHz}$   
So that 1 cycle is about 0.55873 micro-seconds.
3. The total number of cycles in ONE LOOP has been carefully calculated.
4. The cycle count calculation is given as follow:

```
CLEAR   : 1041 T
MSG     : 4956 T
BFUPDT  : 1747 T
SCAN1   : 28898 T
TMUPDT  : 258 T
```

The total number of counts is 1800610.

and

$$0.56 \text{ usec} \times 1800610 \div 2 = 1.008 \text{ sec}$$

5. Flowchart of clock

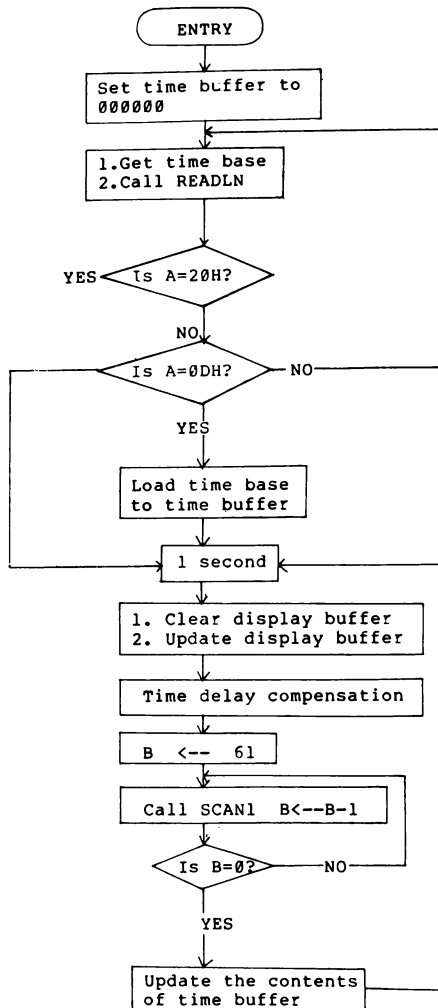
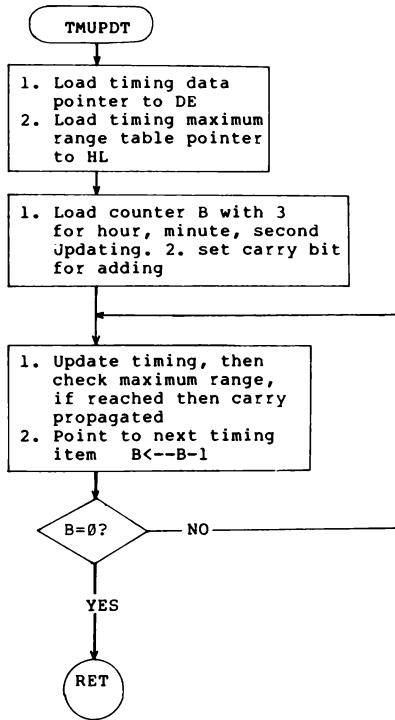
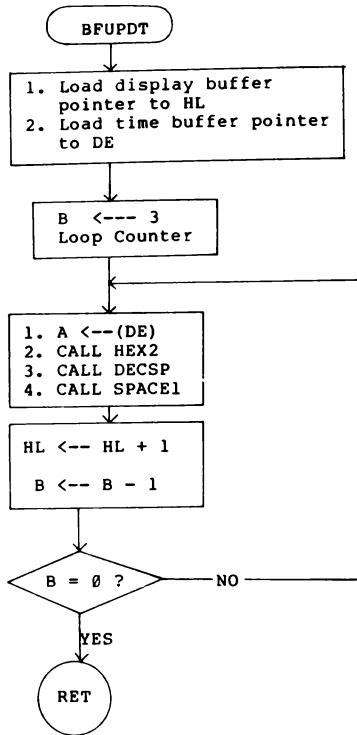

Fig. 13-1 Flowchart of clock

# Time Update Flowchart



# Display buffer Update Flowchart



```

      1 ;
      2 ;A software driven digit clock.
      3 ;
FB00  4          ORG      0FB00H
      5 START:
FB00  6          CALL    CLEAR
FB03  7          LD      B,3
FB05  8          LD      HL, HOUR
FB08  9          LOOP1  LD      (HL),0 ;This loop initial
FB0A 10         INC     HL ;the time buffer.
FB0B 11         DJNZ   LOOP1
FB0D 12         LD      HL,FORMAT
FB10 13         CALL   MSG
FB13 14         CALL   READLN ;Get time base.
FB16 15         JR      Z,MAIN ;If input line contain
      16 ;only <CR>,then jump to
      17 ;MAIN.Otherwise, get HOUR
      18 ;, MIN and SEC.
FB18 19         CDDF08  CALL   CHKHEX
FB1B 20         0603   LD      B,3
FB1D 21         2175FB LD      HL, HOUR
FB20 22         E5     LOOP2  PUSH   HL
FB21 23         CDE508  CALL   GETHL
FB24 24         E1     POP    HL
FB25 25         77     LD      (HL),A
FB26 26         23     INC     HL
FB27 27         10F7   DJNZ   LOOP2
      28 MAIN:
FB29 29         CDB909  CALL   CLEAR
FB2C 30         CD59FB  CALL   BFUPDT
FB2F 31         063E   LD      B,62
FB31 32         DD212CFF LD      IX,DISPFB
FB35 33         CD9B02  LOOP3  CALL   SCAN1
FB38 34         10FB   DJNZ   LOOP3
FB3A 35         CD3FFB  CALL   TMUPDT
FB3D 36         18EA   JR      MAIN
      37 ;
      38 ;Time_buffer is updated here.
      39 ;This routine takes almost the same time
      40 ;in any condition.
      41 ;
      42 TMUPDT:
FB3F 43         217AFB   LD      HL,MAXTAB+2
FB42 44         1177FB   LD      DE,SEC
FB45 45         C5     PUSH   BC
FB46 46         0603   LD      B,3
FB48 47         37     SCF      ;Set carry flag: force
      48 ;add 1.
FB49 49         1A     TMINC  LD      A,(DE)
FB4A 50         CE00   ADC     A,0
FB4C 51         27     DAA
FB4D 52         12     LD      (DE),A
FB4E 53         96     SUB     (HL) ;Compare with data in
      54 ;MAX_TAB. If the result is
      55 ;less than that,the follow-
      56 ;ing loop will be null.
FB4F 57         3801   JR      C,COMPL
FB51 58         12     LD      (DE),A

```

LOC	OBJ CODE M	STMT	SOURCE	EXPL4 STATEMENT
FB52	3F	59	COMPL	CCF
FB53	2B	60		DEC HL
FB54	1B	61		DEC DE
FB55	10F2	62		DJNZ TMINC
FB57	C1	63		POP BC
FB58	C9	64		RET
		65		;
		66		;Display_buffer is updated here.
		67		;This routine takes the same time in
		68		;any condition.
		69		;
		70		BFUPDT:
FB59	2138FF	71		LD HL,DISPBF+12 ;Set display buffer
		72		;pointer.
FB5C	2284FF	73		LD (DISP),HL
FB5F	1175FB	74		LD DE,TMBF
FB62	0603	75		LD B,3
FB64	1A	76	LOOP4	LD A,(DE)
FB65	CD9A0A	77		CALL HEX2
FB68	CD9903	78		CALL DECSP
FB6B	CD950A	79		CALL SPACE1
FB6E	13	80		INC DE
FB6F	10F3	81		DJNZ LOOP4
FB71	CD9903	82		CALL DECSP
FB74	C9	83		RET
		84		;;
		85		TMBF:
FB75		86	HOUR	DEFS 1
FB76		87	MIN	DEFS 1
FB77		88	SEC	DEFS 1
FB78	24	89	MAXTAB	DEFB 24H
FB79	60	90		DEFB 60H
FB7A	60	91		DEFB 60H
FB7B	54494D45	92	FORMAT	DEFM 'TIME BASE='
FB85	0D	93		DEFB 0DH
		94	CLEAR	EQU 09B9H
		95	CURSOR	EQU 0A79H
		96	DISP	EQU 0FF84H
		97	MSG	EQU 09CAH
		98	DECSP	EQU 0399H
		99	CHKHEX	EQU 08DFH
		100	DISPBF	EQU 0FF2CH
		101	HEX2	EQU 0A9AH
		102	READLN	EQU 09D4H
		103	GETHL	EQU 08E5H
		104	SCAN1	EQU 029BH
		105	SPACE1	EQU 0A95H
		106		END

## II. Illustrations of the Experiments

1. Load the program
2. When the program is executed, the MPF-IP display will first display TIME BASE = \ , prompting the user to enter hour, minute, second. Hour, minute, second should be separated by the space key, and followed by a carriage return. When the carriage return key is pressed, the clock begins clicking. If the user does not key in time, the clock begins from 0 hour, 0 minute, 0 second.

Example: The clock is to begin counting from 10:30:00, then type in

- 1) 

G	F	B	0	0	←
---	---	---	---	---	---

      The display will show  
TIME BASE = \
  - 2) Type in 10 30 00      The display will show  
10 30 00
  - 3) The clock begins counting.
3. Modify the program to improve the accuracy of the clock. Make the MPF-IP a 12-hour clock, and display "AM" or "PM" when the time is shown.



# Experiment 15

## Telephone Tone Simulation

### Purposes:

1. To simulate a telephone ring.
2. To familiarize the reader with the application of 'tone' subroutine.

Time required: 4 hours.

### I. Theoretical Background:

1. The telephone ring can be simulated as a repeating 1 second tone with 2 seconds silence.
2. This tone is a frequency shift keying signal modulated by two 20HZ square waves (half-period of 25 m sec). The low & high states of this 20HZ signal correspond to 320HZ and 480HZ, so that it takes 8 & 12 cycles respectively.
3. In the following program, register C controls the frequency of the sound and register pair HL controls the length of the sound.

- a. Low frequency: C = 211, HL = 8, so the period is

$$(44 + 13 \times 211) \times 2 \times 0.56 = 3121 \text{ micro-sec.}$$

$$\text{frequency : } f = 1/3121 = 320\text{Hz}$$

$$\text{length of the sound: } 3121 \text{ micro-sec} \times 8 = 25\text{m sec.}$$

- b. High frequency: C = 140, HL = 12, so the period is

$$(44 + 13 \times 140) \times 2 \times 0.56 = 2087 \text{ micro-sec}$$

$$\text{frequency: } 1/2087 = 480\text{Hz.}$$

$$\text{length of the sound: } 2087 \text{ micro-sec} \times 2 = 25\text{m sec.}$$

#### 4. Output Circuit of tone

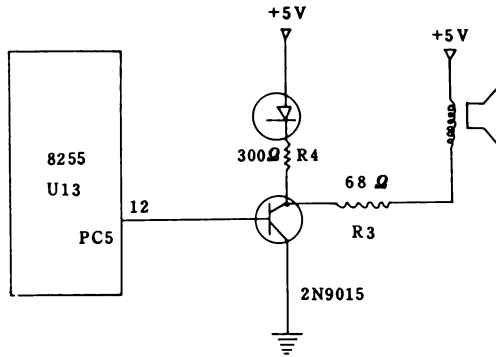

The output of the tone is sent via PC5 of 8255, 2N9015, R3, to the speaker. When the voltage of PC5 is low, the transistor will conduct; when the voltage of PC5 is high, the transistor will nonconduct. By means of the transistor conducts and nonconducts, the speaker will make sound.

## 5. Flowchart of Telephone Tone

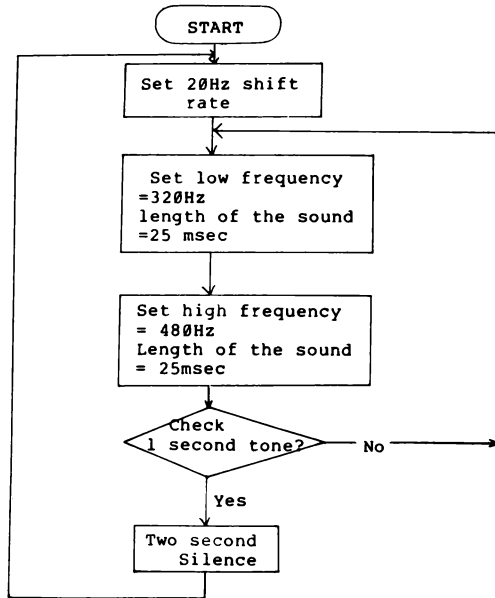

Flowchart of a telephone tone simulation

6. Telephone Tone Program

```

                                EXP15
                                PAGE 1
LOC  OBJ CODE M STMT SOURCE STATEMENT                                ASM 5.9

                                1 ;TELEPHONE TONE
FB00                                2          ORG          0FB00H
FB00  3E14                            3 RINGBK  LD          A,20      ;20HZ freq shift rate
                                4                                ;so that 1 sec has 20 loops.
FB02  08                              5 RING    EX          AF,AF'  ;Save to A'
FB03  0ED3                            6          LD          C,211
FB05  210800                          7          LD          HL,8
FB08  CD7408                          8          CALL       TONE    ;320HZ, .25 m sec
FB08  0E8C                              9          LD          C,140
FB0D  210C00                          10         LD          HL,12
FB10  CD7408                          11         CALL       TONE    ;480HZ, 25 m sec
FB13  08                              12         EX          AF,AF' ;Retrieve from A'
FB14  3D                              13         DEC         A      ;Decrement 1 count
FB15  20EB                            14         JR          NZ,RING
FB17  0150C3                          15         LD          BC,50000
FB1A  CD1FFB                          16         CALL       DELAY   ;Silent 2 sec
FB1D  18E1                            17         JR          RINGBK
                                18 ;Delay subroutine: (BC)*40 micro_sec
                                19 ;based on the 1.79 MHZ system clock
FB1F  E3                              20 DELAY  EX          (SP),HL ;19 states
FB20  E3                              21         EX          (SP),HL ;19
FB21  EDA1                            22         CPI         ;16
FB23  E0                              23         RET         PO     ;5
FB24  18F9                            24         JR          DELAY   ;12
                                25 ;
                                26 TONE   EQU         0874H
                                27         END

```

II. Example and Practice Experiments

1. Load the above program into MPF-IP and then execute it.
2. Execute the program and listen to it. Does it sound like a telephone ring? If it doesn't, try to modify the frequency of the tone.
3. Try to simulate the telephone busy tone

Hint: The busy tone can be simulated as follows: a repeating 0.5 second 400HZ tone with 0.5 seconds of silence.

# Experiment 16

## Microcomputer Organ

### Purposes:

1. To enable the part of the Microprofessor to simulate an electronic organ.
2. To familiarize the reader with the application of the keyboard -scanning routine.

Time Rquired: 4 hours

### I. Theoretical Background:

1. This experiment converts the MPF-IP into a simple electronic organ.
2. When a key is pressed, the speaker will generate a tone corresponding to this key. This tone will not terminate until the key is released.
3. Acceptable keyboard: key 0 - key F.

If other keys are entered, the response is unpredictable.

### 4. Key Mapping To Tones

	Q	W	E	R	T	Y	U
	Ċ	Ď	Ě	Ě	Ĝ	Ĥ	Ĕ
A	S	D	F	G	H	J	
C	D	E	F	G	A	B	
		V	B	N	M		
		F	G	A	B		

5. An octave ranges from a C to a B. The octave is divided into 5 full-tone and 2 half-tones, which equals to 12 half-tones, as follows:

C #C D #D E F #F G #G A #A B

The next octave is just twice the frequency of the current one, There is a logarithmic relationship between each half-tone. The frequency of each half-tone can be calculated by multiplying the last one by  $2^{1/12}$ , which is approximately 1.059.

For example, if the frequency of E is 503HZ, then the frequency of F is equal to

$$503\text{HZ} \times 1.059 = 532\text{HZ}.$$

6. Flow chart of microcomputer organ program

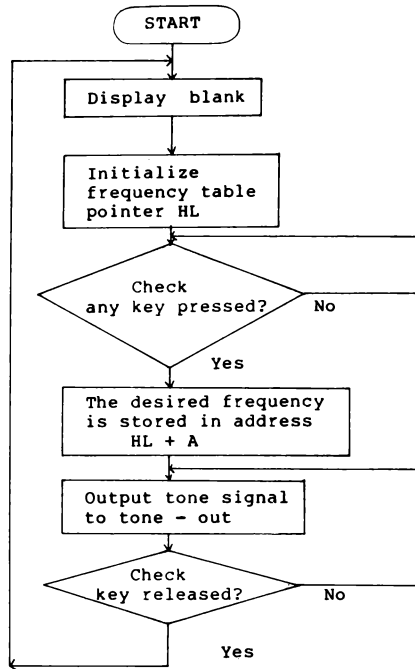

Flowchart of organ

## 7. ORGAN Program:

LOC	OBJ CODE M	STMT	SOURCE	STATEMENT	EXPL6	PAGE 1
						ASM 5.9
		1		;MICROCOMPUTER ORGAN		
FB00		2		ORG 0FB00H		
FB00	DD21D06F	3	START	LD IX,BLANK		
FB04	CD4D02	4		CALL SCAN2 ;Display blank,return		
		5		;when any key is pressed		
		6		;A reg contains the key_code		
FB07	2134FB	7		LD HL,FREQTAB ;Based address of		
		8		;frequency table		
		9		;		
		10		;After routine SCAN2, A reg contain the code of the		
		11		;key pressed. Using this code as table offset.		
		12		;The desired frequency is stored in addresss HL+A		
FB0A	D641	13		SUB 41H ;Get offset of FREQTAB		
FB0C	85	14		ADD A,L ;Add A to HL		
FB0D	6F	15		LD L,A		
FB0E	3EDF	16		LD A,0DFH		
		17	HALF:			
FB10	D392	18		OUT (KIN),A ;Output tone signal to		
		19		;tone_out		
FB12	46	20		LD B,(HL) ;Get the frequency from		
		21		;FREQTAB.		
FB13	00	22	DELAY	NOP		
FB14	00	23		NOP		
FB15	00	24		NOP		
FB16	10FB	25		DJNZ DELAY		
FB18	EE20	26		XOR 20H ;Complement bit 5 of A.		
FB1A	4F	27		LD C,A		
FB1B	AF	28		XOR A		
FB1C	D380	29		OUT (80H),A ;Activate the first 8 columns		
		30		;of the keyboard matrix.		
FB1E	D381	31		OUT (81H),A ;Activate next 8 columns of		
		32		;the keyboard matrix.		
FB20	D382	33		OUT (82H),A ;Activate the last 4 columns		
		34		;of the keyboard matrix.		
FB22	DB92	35		IN A,(KIN) ;Check whether this key is		
		36		;pressed or not. If any key		
		37		;is pressed, the corresponding		
		38		;matrix row input must be low.		
FB24	F6F8	39		OR 0F8H		
FB26	3C	40		INC A ;If A is 1111111B, increase A		
		41		;by one will make a zero and		
		42		;set zero flag.		
FB27	3EFF	43		LD A,0FFH		
FB29	D380	44		OUT (80H),A ;Disable the first 8 columns		
		45		;of the keyboard matrix and		
		46		;digits.		
FB2B	D381	47		OUT (81H),A ;Disable next 8 columns of		
		48		;the keyboard matrix and		
		49		;digits		
FB2D	D382	50		OUT (82H),A ;Disable the last 4 columns		
		51		;of the keyboard matrix and		
		52		;digits.		
FB2F	79	53		LD A,C ;Restore A from reg C.		
FB30	28CE	54		JR Z,START ;If all key released,restart.		
		55		;otherwise,continue this		
		56		;frequency.		
FB32	18DC	57		JR HALF		
		58				



```

59  FREQTAB:
FB34  A8      60      DEFB      0A0H      ;Key A
FB35  E0      61      DEFB      0E0H      ;Key B
FB36  00      62      DEFB      00      ;Key C
FB37  85      63      DEFB      85H      ;Key D
FB38  42      64      DEFB      42H      ;Key E
FB39  7E      65      DEFB      7EH      ;Key F
FB3A  70      66      DEFB      70H      ;Key G
FB3B  64      67      DEFB      64H      ;Key H
FB3C  00      68      DEFB      00      ;Key I
FB3D  59      69      DEFB      59H      ;Key J
FB3E  00      70      DEFB      00      ;Key K
FB3F  00      71      DEFB      00      ;Key L
FB40  B2      72      DEFB      0B2H      ;Key M
FB41  C8      73      DEFB      0C8H      ;Key N
FB42  00      74      DEFB      00      ;Key O
FB43  00      75      DEFB      00      ;Key P
FB44  54      76      DEFB      54H      ;Key Q
FB45  3E      77      DEFB      3EH      ;Key R
FB46  96      78      DEFB      96H      ;Key S
FB47  37      79      DEFB      37H      ;Key T
FB48  2C      80      DEFB      2CH      ;Key U
FB49  FB      81      DEFB      0FBH      ;Key V
FB4A  4A      82      DEFB      4AH      ;Key W
FB4B  00      83      DEFB      00      ;Key X
FB4C  31      84      DEFB      31H      ;Key Y
FB4D  00      85      DEFB      00      ;Key Z
      86      ;
      87  BLANK  EQU      6FD0H
      88  KIN   EQU      92H
      89  SCAN2 EQU      024DH
      90      END.

```

## II. Example and Practice Experiments

1. Load the above program into MPP-IP and then store it on audio tape.
2. Execute the program. When a key is pressed, the speaker will generate a tone corresponding to this key.  
  
Are these tones accurate?
3. Try to play a song using this organ.
4. Extend this program so that more keys of the keyboard can be used as input keys of the organ.

# Experiment 17

## Music Box Simulation

### Purposes:

1. To construct a music box.
2. To familiarize the reader with programming techniques.

Time Required: 4 hours.

### I. Theoretical Background:

1. This experiment generates a song using programming techniques.
2. There are two tables (frequency-table & song-table) in this program, which is described below:

#### a. Frequency-table

Every element of this table has 2 bytes, the 1st byte is the frequency parameter and the 2nd byte is the number of half-periods in a unit-time duration.

One octave ranges from C to B. It is divided into 5 full-tones and 2 half-tones, which equals 12 half-tones, as follows:

C #C D #D E F #F G #G A #A B

The next octave is just twice the frequency of the current one, and there is a logarithmic relationship between each half-tone. So that the frequency of each half-tone can be calculated by multiplying the last tone by  $2^{1/12}$ , which is approximately 1.059.

#### b. Song-Table:

Each element of this table has 2 bytes:

The 1st byte contains the code of the NOTE or REST or command of REPEAT or STOP. These codes are:

bit 7 ---- STOP  
bit 6 ---- REPEAT  
bit 5 ---- REST  
bit 4-0 ---- NOTE CODE

The 2nd byte contains the counts of the unit-time, i.e. the NOTE length.

3. A flowchart of music box simulation is given below:

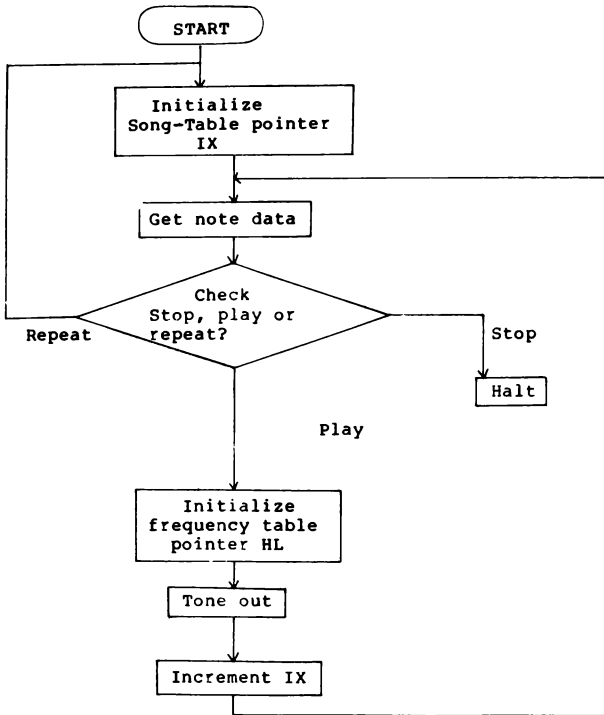

Fig 17-1 Flowchart of music box simulation

```

      1 ;
      2 ;MUSIC BOX
      3 ;
FB00      4          ORG      0FB00H
FB00      5 DD2100F9      LD      IX,SONG ;Initial song_table
      6          ;pointer.
FB04      7 DD7E00      7. FETCH  LD      A,(IX) ;Get note data
FB07      8 87          8 ADD      A,A ;Each note data have 2
      9          ;bytes.
FB08      10 3830      10 JR      C,STOP ;Stop?
FB0A      11 FA00FB      11 JP      M,START ;Repeat?
FB0D      12 0E00      12 LD      C,0 ;Reset tone_bit.
FB0F      13 CB77      13 BIT     6,A ;Reset?
FB11      14 2002      14 JR      NZ,PLAY
FB13      15 CBE9      15 SET     5,C ;Set tone bit
FB15      16 E63F      16 PLAY   AND     3FH ;Mask out_note data.
FB17      17 213BFB      17 LD      HL,FRQTAB
FB1A      18 85          18 ADD     A,L
FB1B      19 6F          19 LD      L,A ;Locate pointer in FRQTAB.
FB1C      20 5E          20 LD      E,(HL) ;Counts of loop per HALF_
      21          ;PERIOD delay.
FB1D      22 23          22 INC     HL
FB1E      23 56          23 LD      D,(HL) ;Counts of HALF_PERIODS
      24          ;per UNIT_TIME.
FB1F      25 DD23      25 INC     IX
FB21      26 DD6600      26 LD      H,(IX) ;Counts of UNIT_TIME for
      27          ;this note.
FB24      28 3EFF      28 LD      A,0FFH
      29          ;
      30 ;The following loop runs for one note or rest:
      31 ;
FB26      32 6A          32 TONE   LD      L,D
FB27      33 D392      33 UNIT   OUT     (92H),A ;Bit 5 is tone_out.
FB29      34 43          34 LD      B,E
FB2A      35 30          35 DELAY  NOP
FB2B      36 00          36 NOP
FB2C      37 00          37 NOP
FB2D      38 10FB      38 DJNZ   DELAY
FB2F      39 A9          39 XOR     C ;If C=00H then reset.
      40          ;If C=00H then tone_out
FB30      41 2D          41 DEC     L
FB31      42 20F4      42 JR      NZ,UNIT
FB33      43 25          43 DEC     H
FB34      44 20F0      44 JR      NZ,TONE
      45          ;
      46 ;The current note has ended, increment pointer
      47 ;next.
      48          ;
FB36      49 DD23      49 INC     IX
FB38      50 18CA      50 JR      FETCH
FB3A      51 76          51 STOP   HALT
      52          ;
      53 FRQTAB:
      54          ;
      55 ;1st byte:counts of DELAY loop per HALF_PERIOD.
      56 ;2nd byte:counts of HALF_PERIOD per UNIT-TIME.
      57 ;OCTAVE 3
FB3B      58 E118      58 DEFW   18E1H ;Code 00 , G

```

LOC OBJ CODE M STMT SOURCE STATEMENT ASM 5.9

```

FB3D  D41A      59      DEFW  1AD4H ;Code 01 , #G
FB3F  C81B      60      DEFW  1BC8H ;Code 02 , A
FB41  BD1D      61      DEFW  1DBDH ;Code 03 , #A
FB43  B21E      62      DEFW  1E82H ;Code 04 , B
      63      ;OCTAVE 4
FB45  AB20      64      DEFW  20A8H ;Code 05 , C
FB47  9F22      65      DEFW  229FH ;Code 06 , #C
FB49  9624      66      DEFW  2496H ;Code 07 , D
FB4B  8D26      67      DEFW  268DH ;Code 08 , #D
FB4D  8529      68      DEFW  2985H ;Code 09 , E
FB4F  7E2B      69      DEFW  2B7EH ;Code 0A , F
FB51  7723      70      DEFW  2E77H ;Code 0B , #F
FB53  7031      71      DEFW  3170H ;Code 0C , G
FB55  6A33      72      DEFW  336AH ;Code 0D , #G
FB57  6437      73      DEFW  3764H ;Code 0E , A
FB59  5E3A      74      DEFW  3A5EH ;Code 0F , #A
FB5B  593D      75      DEFW  3D59H ;Code 10 , B
      76      ;OCTAVE 5
FB5D  5441      77      DEFW  4154H ;Code 11 , C
FB5F  4F45      78      DEFW  454FH ;Code 12 , #C
FB61  4A49      79      DEFW  494AH ;Code 13 , D
FB63  464D      80      DEFW  4D46H ;Code 14 , #D
FB65  4252      81      DEFW  5242H ;Code 15 , E
FB67  3E57      82      DEFW  573EH ;Code 16 , F
FB69  3B5C      83      DEFW  5C3BH ;Code 17 , #F
FB6B  3762      84      DEFW  6237H ;Code 18 , G
FB6D  3467      85      DEFW  6734H ;Code 19 , #G
FB6F  316E      86      DEFW  6E31H ;Code 1A , A
FB71  2E74      87      DEFW  742EH ;Code 1B , #A
FB73  2C7B      88      DEFW  7B2CH ;Code 1C , B
      89      ;OCTAVE 6
FB75  2982      90      DEFW  8229H ;Code 1D , C
FB77  278A      91      DEFW  8A27H ;Code 1E , #C
FB79  5592      92      DEFW  9255H ;Code 1F , D
      93      ;
      94      ;1st byte,bit 7,6,5 & 4-0 : stop, repeat, rest, note
      95      ; Code of stop : 80H
      96      ; Code of repeat : 40H
      97      ; Code of rest : 20H
      98      ;2nd byte, note lenth: counts of UNIT_TIME
      99      ;(N*0.77 sec).
100    ;
101    ;JINGLE BELL: (TRUNCATED)

```

F900		102	SONG	ORG	0F900H
F900	09	103		DEFB	9
F901	04	104		DEFB	4
F902	09	105		DEFB	9
F903	04	106		DEFB	4
F904	09	107		DEFB	9
F905	06	108		DEFB	6
F906	20	109		DEFB	20H
F907	02	110		DEFB	2
F908	09	111		DEFB	9
F909	04	112		DEFB	4
F90A	09	113		DEFB	9
F90B	04	114		DEFB	4
F90C	09	115		DEFB	9
F90D	06	116		DEFB	6

EXP12  
LOC OBJ CODE M STMT SOURCE STATEMENT

PAGE 2  
ASM 5.9

FB3D	FEFF	59	DEFW	0FFFEH	;SEG_a
FB3F	08	60	DEFB	8	;DIGIT 9
FB40	FEFF	61	DEFW	0FFFEH	;SEG_a
FB42	09	62	DEFB	9	;DIGIT 10
FB43	FEFF	63	DEFW	0FFFEH	;SEG_a
FB45	0A	64	DEFB	10	;DIGIT 11
FB46	FEFF	65	DEFW	0FFFEH	;SEG_a
FB48	0B	66	DEFB	11	;DIGIT 12
FB49	FEFF	67	DEFW	0FFFEH	;SEG_a
FB4B	0C	68	DEFB	12	;DIGIT 13
FB4C	FEFF	69	DEFW	0FFFEH	;SEG_a
FB4E	0C	70	DEFB	12	;DIGIT 13
FB4F	FDFD	71	DEFW	0FFFDH	;SEG_b
FB51	0C	72	DEFB	12	;DIGIT 13
FB52	FBFF	73	DEFW	0FFFBH	;SEG_c
FB54	0C	74	DEFB	12	;DIGIT 13
FB55	F7FF	75	DEFW	0FFF7H	;SEG_d
FB57	0B	76	DEFB	11	;DIGIT 12
FB58	F7FF	77	DEFW	0FFF7H	;SEG_g
FB5A	0A	78	DEFB	10	;DIGIT 11
FB5B	F7FF	79	DEFW	0FFF7H	;SEG_d
FB5D	09	80	DEFB	9	;DIGIT 10
FB5E	F7FF	81	DEFW	0FFF7H	;SEG_d
FB60	08	82	DEFB	8	;DIGIT 9
FB61	F7FF	83	DEFW	0FFF7H	;SEG_d
FB63	07	84	DEFB	7	;DIGIT 8
FB64	F7FF	85	DEFW	0FFF7H	;SEG_d
FB66	07	86	DEFB	7	;DIGIT 8
FB67	EFFE	87	DEFW	0FFFEH	;SEG_e
FB69	07	88	DEFB	7	;DIGIT 8
FB6A	DFFF	89	DEFW	0FFFDH	;SEG_f
FB6C	FF	90	DEFB	0FFH	;REPEAT CODE.
		91	END		

```

F90E 20      117      DEFB  20H
F90F 02      118      DEFB  2
F910 09      119      DEFB  9
F911 04      120      DEFB  4
F912 0C      121      DEFB  0CH
F913 04      122      DEFB  4
F914 05      123      DEFB  5
F915 04      124      DEFB  4
F916 07      125      DEFB  7
F917 04      126      DEFB  4
F918 09      127      DEFB  9
F919 08      128      DEFB  8
F91A 20      129      DEFB  20H
F91B 08      130      DEFB  8
F91C 80      131      DEFB  80H
132      ;
133      ;The following data are codes of song 'GREEN SLEEVES'
134      ;The user can put them at the SONG-TABLE, i.e. from
135      ;0F900 it will play until 'RESET' key is pressed.
136      ;
137      ;
138      ;F900 07 08 0A 10 0C 08 0E 10 10 04 0E 04 0C 10 09 08 08
139      ;F910 05 10 07 04 09 04 0A 10 07 08 07 10 06 04 07 04
140      ;F920 09 10 06 08 02 10 07 08 0A 10 0C 08 0E 10 10 04
141      ;F930 0E 04 0C 10 09 08 05 10 07 04 09 04 0A 08 09 08
142      ;F940 07 08 06 08 04 08 06 08 07 10 20 08 11 10 11 08
143      ;
144      ;F950 11 10 10 04 0E 04 0C 10 09 08 05 10 07 04 09 04
145      ;F960 0A 10 07 08 07 10 06 04 07 04 09 10 06 08 02 10
146      ;F970 20 08 11 10 11 08 11 10 10 04 0E 04 0C 10 09 08
147      ;F980 05 10 07 04 09 04 0A 08 09 08 07 08 06 08 04 08
148      ;F990 06 08 07 18 20 10 40
149      ;
150      END
  
```



**Multitech**  
INDUSTRIAL CORP.

OFFICE /  
9FL, 266 SUNG CHIANG ROAD, TAIPEI 104,  
TAIWAN, R.O.C  
TEL: (02)551-1101  
TELEX: 19162 MULTIC FAX: (02)542-2805  
FACTORY /  
1 INDUSTRYE ROAD, III,  
HSINCHU SCIENCE-BASED INDUSTRIAL PARK,  
HSINCHU, TAIWAN 300, R.O.C.