

ALTOS 586 AND ACS 8600 COMPUTER SYSTEMS

INTRODUCTION TO XENIX

**Altos Computer Systems
2641 Orchard Park Way
San Jose, CA 95134**

**THE INFORMATION IN THIS DOCUMENT IS SUBJECT TO
CHANGE WITHOUT NOTICE. NEW EDITIONS OF THIS
DOCUMENT WILL INCORPORATE CHANGES AS THEY ARE
PUBLISHED.**

Copyright ©1983. All rights reserved. Altos Computer Systems.

ALTOS Manual Number: 690-13499-002

May 1983

ACKNOWLEDGEMENTS

ALTOS is a registered trademark of Altos Computer Systems.

XENIX is a trademark of Microsoft, Incorporated and is a 16-bit microcomputer implementation of the UNIX operating system, version 7.

UNIX is a trademark of Bell Laboratories

UNET is a trademark of 3Com Corporation

TABLE OF CONTENTS

ABOUT THIS MANUAL

USING THIS MANUAL	ix
Purpose/Scope	ix
Organization	x
DOCUMENTATION CONVENTIONS	xiii
OTHER INFORMATION AVAILABLE	xiv
XENIX Reference Card	xiv
Altos Applications Software User Guide	xiv
Altos UNET User Guide	xiv
Altos XENIX Development System Programmer's Reference Guide	xiv
UNIX Programmer's Manual	xv
Commercially-Available Books	xv

INTRODUCTION:

1. INTRODUCTION TO OPERATING SYSTEM CONCEPTS

WHAT IS AN OPERATING SYSTEM?	1-2
WHAT IS A PROCESS?	1-3
WHAT IS BOOTING?	1-4
WHAT IS A COMMAND LANGUAGE?	1-5
WHAT IS A COMMAND?	1-6
WHAT IS A COMMAND FORMAT?	1-7
WHAT IS A CONTROL CHARACTER?	1-8
WHAT IS A SYSTEM PROMPT?	1-9
WHAT IS A UTILITY?	1-10
WHAT IS A FILE?	1-11
WHAT IS A DIRECTORY?	1-13
WHAT IS AN EDITOR?	1-14
WHAT IS LOGGING ON AND OFF THE SYSTEM?	1-15

2. INTRODUCTION TO XENIX OPERATING SYSTEM CONCEPTS

WHAT IS XENIX?	2-2
UNIX AND ALTOS XENIX CONCEPTS	2-3
Shells and the Kernel	2-3
ABS (Altos Business Solution) Menu Shell	2-3
BSH -- The Business Shell	2-5
Further Information	2-5
XENIX FILE AND DIRECTORY CONCEPTS	2-6
Directories and Subdirectories	2-6
Attributes, Permissions, and Ownership	2-8
Limitations	2-8
SYSTEM CONFIGURATION	2-10
Terminals	2-10

TABLE OF CONTENTS

2. INTRODUCTION TO XENIX OPERATING SYSTEM CONCEPTS (CONT.)

Configuring Terminals for the Business Shell	2-10
Printer	2-10

3. INTRODUCTION TO THE BUSINESS SHELL MENU SYSTEM

INTRODUCTION	3-1
Display Menu	3-2
Fast-Mode/Slow-Mode	3-2
BASIC UTILITIES	3-6
Change a Directory	3-6
Change a Password	3-6
List a Directory	3-6
Create a Directory	3-6
Remove a Directory	3-6
Edit a File (ed)	3-7
Remove a File	3-7
Copy and/or Combine Files	3-7
Display Files	3-7
Print Files	3-7
SYSTEM AND HELP	3-9
SYSTEM ADMINISTRATION	3-9
System Management	3-11
User Administration	3-11
Backup/Restore Files	3-12
Port Configuration	3-12
Utilities	3-12
Time and Date	3-12
Who is on the System?	3-12
Display Processes	3-13
Kill Processes	3-13
Become Super-User	3-13
Shutdown	3-13
Directories and Files	3-13
Change Directory	3-13
List Directory	3-13
Change File Permissions	3-14
Change File Ownership	3-14
Change File Group	3-14
File Space	3-14
ELECTRONIC MAIL	3-15
RUN A PROGRAM	3-15
NETWORK SERVICES	3-16
QUIT (LOGOUT)	3-16
HELP	3-18
Business Shell Commands	3-18
Business Shell Menus	3-19

TABLE OF CONTENTS

4. INTRODUCTION TO SYSTEM ADMINISTRATION AND MAINTENANCE

ROLE OF THE SYSTEM ADMINISTRATOR (SUPER-USER)	4-2
BECOMING SYSTEM ADMINISTRATOR AND SUPER-USER	4-3
PROTECTING SYSTEM ADMINISTRATOR AND SUPER-USER LOGIN NAMES	4-4
RESPONSIBILITIES OF THE SYSTEM ADMINISTRATOR	4-5
Installing the XENIX Operating System	4-5
Upgrading the XENIX Operating System	4-5
Adding or Changing User Accounts	4-5
Checking and Cleaning Up Files (fsck)	4-5
Saving and Backing up the File System (tar)	4-6
Managing Disk Space on the System (du, df)	4-7
Displaying and Killing Processes (ps, kill)	4-8
Configuring Ports (pconfig)	4-8
Shutting Down the System (shutdown, haltsys)	4-9
Troubleshooting the System	4-9

INSTALLING XENIX:

5. INSTALLING XENIX

PRIOR STEPS	5-2
PROCEDURE FOR INSTALLING XENIX	5-4
RESUMING INTERRUPTED INSTALLATION	5-14

6. UPGRADING OLDER VERSIONS OF XENIX

PROCEDURE A	6-3
Overview of Procedure A	6-3
Detailed Installation for Procedure A	6-3
PROCEDURE B	6-5
Overview of Procedure B	6-5
Detailed Installation for Procedure B	6-5
RESUMING INTERRUPTED INSTALLATION	6-12

TABLE OF CONTENTS

USING XENIX:

7. GETTING STARTED WITH XENIX

GETTING STARTED IN THE UNIX SHELL	7-2
AVAILABLE LOGIN NAMES AND SHELLS	7-3
Using Login Names and Shells	7-4
CONFIGURING THE PORTS	7-8
CREATING AND CHANGING USER ACCOUNTS	7-12
Creating a User Account	7-12
Other Available Commands	7-14
Guidelines	7-14

8. STARTING UP XENIX

BOOTING FROM HARD DISK	8-1
RECOVERING FROM IMPROPER SHUTDOWN	8-4

9. LOG IN, LOG OFF, AND QUIT

LOGGING IN AND PASSWORDS	9-1
SETTING AND CHANGING PASSWORDS	9-2
SETTING SYSTEM ADMINISTRATION PASSWORDS	9-4
LOGGING OFF OR QUITTING	9-5

10. USING XENIX ON A REGULAR BASIS

USING THE BUSINESS SHELL MENU SYSTEM	10-1
Moving Between the Shells	10-2
Accessing the Business Shell from the UNIX Shell	10-3
CONTROL CHARACTER SEQUENCES	10-4
BASIC UTILITIES	10-5
Changing Directory	10-5
Creating a Directory	10-5
Listing Directory	10-7
Removing a Directory	10-7
Editing a File	10-8
Removing a File	10-8
Copying and/or Combining Files	10-8
Displaying a File	10-9
Printing a File	10-10
SYSTEM ADMINISTRATION UTILITIES	10-11
SAVING AND RESTORING FILES	10-11
Using Tape Archive Utility (<i>tar</i>)	10-11
Using Tape Archive Utility from BSH Menu System	10-11
Formatting Diskettes	10-12
Saving Files	10-13

TABLE OF CONTENTS

10. USING XENIX ON A REGULAR BASIS (CONT.)

Restoring Files	10-14
Typical Session	10-15
Listing Saved Files	10-16
Filenames and Directories	10-16
Using <u>tar</u> to Move Files	10-16
Using <u>tar</u> with Tape Cartridge Option	10-17
Handling Diskettes	10-20
RANDOM ACCESS DISKETTE FILES	10-21
Initializing Diskettes as Random-Access Files	10-21
Mounting a Diskette	10-21
Dismounting a Diskette	10-22
CHECKING AND CLEANING UP FILES	10-23
Command Syntax and Options	10-24
SHUTTING DOWN XENIX	10-27
Business Shell Procedure	10-27
UNIX Shell: For Multiple Users	10-27
UNIX Shell: For Single User	10-28
MORE BASIC UTILITIES	10-29
Displaying or Setting the Time and Date	10-29
Displaying Who is on the System	10-29
Displaying Processes	10-30
Killing Processes	10-31
Becoming Super-User	10-32
Listing Directory (Long Form)	10-33
Changing File Permissions	10-33
Changing File Ownership	10-35
Changing File Groups	10-35
Displaying Disk Usage (File Space)	10-36
USING ELECTRONIC MAIL FACILITY	10-38
RUNNING A PROGRAM	10-41
USING NETWORK SERVICES FACILITIES (OPTIONAL)	10-42
OBTAINING HELP WHILE IN BUSINESS SHELL	10-43
LIST OF USEFUL COMMANDS AND UTILITIES	10-44

USING TEXT EDITOR:

11. USING THE ED TEXT EDITOR

INTRODUCTION	11-1
ED BASIC CONCEPTS	11-3
Files and Directories	11-3
Text	11-3
Buffer and Disk Space	11-3

TABLE OF CONTENTS

11. USING THE ED TEXT EDITOR (CONT.)

Commands, Command Mode, and Input Mode	11-3
Error Messages	11-4
INVOKING THE ED TEXT EDITOR	11-5
Via the Menu System	11-5
Via the UNIX Shell	11-6
CREATING A NEW FILE	11-7
BASIC ED COMMANDS	11-8
ADDING TEXT (LINES) TO A FILE (a)	11-9
DISPLAYING (LISTING OR PRINTING A FILE (p)	11-10
MAKING CHANGES WITHIN A LINE (s)	11-11
DELETING TEXT (LINES) (d)	11-13
MOVING TEXT (LINES) AROUND IN A FILE (m)	11-14
COMBINING FILES (r)	11-15
SAVING YOUR TEXT/FILE (COPYING FILE TO DISK) (w)	11-16
EXITING (LEAVING) THE EDITOR (q)	11-18
REVIEW EXAMPLES	11-19
Creating a New File	11-19
Creating the File	11-19
Printing the File	11-20
Editing the File	11-20
Displaying the File	11-21
Editing an Existing File	11-22
ADDITIONAL INFORMATION	11-23

APPENDICES:

A. HARD DISK ORGANIZATION

CONFIGURATION	A-1
LOGICAL DEVICES	A-3

B. FLOPPY DISKETTE ORGANIZATION

CONFIGURATION	B-1
LOGICAL DEVICES	B-2

C. CARTRIDGE TAPE ORGANIZATION

MEDIA	C-1
SPECIFICATIONS	C-1
CONFIGURATION	C-2

TABLE OF CONTENTS

D. SERIAL LINE PRINTER AND SPOOLER	
STANDARD PRINTER CONFIGURATION	D-1
HARDWARE CONNECTIONS	D-4
CONNECTING MORE THAN ONE PRINTER	D-5
CHANGING/SETTING BAUD RATES	D-7
CONFIGURING SYSTEM WITHOUT A PRINTER	D-9
SERIAL PRINTER SET UP FOR APPLICATIONS THAT DO NOT USE THE LINE PRINTER SPOOLER	D-10
E. PARALLEL LINE PRINTER AND SPOOLER (ACS 8600 Only)	
F. LIST OF TERMINAL CAPABILITIES	
CUSTOMIZING YOUR ALTOS XENIX SYSTEM	F-2
TERMINALS SUPPORTED BY THE XENIX OPERATING SYSTEM	F-3
G. SAMPLE LISTING OF XENIX RUN-TIME UTILITIES	
H. FILE TRANSFER PROGRAM	
THE FILE TRANSFER UTILITY FOR MP/M-TO- XENIX	H-3
PROCEDURE A	H-3
Description	H-3
Step-by-Step Instructions	H-4
PROCEDURE B	H-9
Description	H-9
Baud Rates	H-9
Step-by-Step Instructions	H-10
THE FILE TRANSFER UTILITY FOR XENIX- TO-XENIX	H-12
PROCEDURE C	H-12
Set Up Procedure	H-12
Baud Rates	H-12
Step-by-Step Instructions	H-13
THE FILE TRANSFER UTILITY FOR XENIX- TO-MP/M	H-15
PROCEDURE D	H-15
Description	H-15
Set Up Procedure	H-15
Baud Rates	H-15
Step-by-Step Instructions	H-16

TABLE OF CONTENTS

GLOSSARY

FIGURES

2-1	Design of Altos XENIX	2-4
2-2	Example of XENIX Hierachal File System	2-7
3-1	Business Shell Menu	3-4
3-2	Business Shell Organization	3-5
3-3	Directory Structure	3-8
3-4	System Administration Menu	3-10
3-5	Network Services Menu	3-17
7-1	Master Control Services Menu	7-6
7-2	The Altos Business Solution Menu	7-7
7-3	Example of Creating a New User Account	7-13
H-1	File Transfer Cable Configuration	H-5

TABLES

6-1	Overview of Upgrade Procedures	6-1
10-1	List of Useful Commands and Utilities	10-44

Preface: About This Manual

USING THIS MANUAL

Purpose/Scope

This manual describes how to use the Altos implementation of the XENIX operating system and the Altos user-friendly man-to-machine interface menu system called the Business Shell (BSH). This manual does not describe how to run the application software that you have purchased with your system. Once the operating system is installed and set up for multiple users, the application user needs to read the **Altos XENIX Applications Software Guide**. This manual is addressed to the system administrator (super-user), who is responsible for maintaining the system. This manual is also written for those who want to use and learn about the XENIX/UNIX operating system.

This guide focuses on two categories of information:

1. Information about the Altos XENIX operating system that cannot be obtained in any other publication on the XENIX or UNIX System because it is unique to the Altos XENIX system.

2. Immediately useful information: information you will want to refer to when you begin using the Altos XENIX operating system.

Other material is available to help in using the Altos XENIX operating system; references are given in this chapter.

Organization

This guide to the Altos XENIX operating system is divided into eleven chapters:

Chapter 1 is primarily written for a novice user of computers and operating systems. It describes the basic operating system concepts found in this manual. Even if you are familiar with computers and operating systems, this chapter can serve as a review.

Chapter 2 explains concepts used in working with the XENIX operating system. It provides background information, including where to get further information.

Chapter 3 explains the Business Shell, which is a special feature supplied by Altos as part of the XENIX operating system. The Business Shell provides special services to you, and contains help and tutorial information.

Chapter 4 discusses the role of the system administrator (super-user). It also discusses the functions to be performed by the system administrator.

Chapter 5 tells you how to install the XENIX operating system.

Chapter 6 offers instructions on installing upgraded versions of the XENIX operating system, without affecting your hard disk files.

Chapter 7 tells you how to get started with XENIX after you have installed the operating system. It also tells you how to set up the system ports for your terminals and printers, and how to set up login user accounts for those who will use the XENIX system.

Chapter 8 tells you how to start up the XENIX system and how to recover from improper shutdowns.

Chapter 9 explains how to access your computer (log in) and how to leave the system when you finish (log off). It also instructs you in setting up passwords for your user accounts.

Chapter 10 explains XENIX functions that are used on a regular basis. These include accessing the system, working with files, executing commands, and running programs. The procedures show you how to perform these functions from the Business Shell and from the standard UNIX Shell.

Chapter 11 explains how to use the standard UNIX line editor called "ed."

The glossary includes a short list of useful definitions.

The appendices contain general reference material.

Appendix A. Hard Disk Organization:

A brief reference describing how the XENIX operating system and user files are allocated on the hard disk.

Appendix B. Floppy Diskette Organization:

A brief reference describing how files are allocated on floppy diskettes.

Appendix C. Cartridge Tape Organization:

Describes the configuration of the cartridge tape drive upgrade for the ACS 8600 computer system.

Appendix D. Serial Line Printer and Spooler:

Information regarding the serial line printer and spooler, such as hardware connections required, configuring your system without a printer, connecting more than one printer, and changing/setting baud rates.

Appendix E. Parallel Line Printer and Spooler (ACS 8600 Only):

Information regarding the parallel line printer and spooler default options and how to change them.

Appendix F. List of Terminal Capabilities:

A data base listing the special capabilities of all terminals supported by the Altos implementation of XENIX.

Appendix G. Sample Listing of XENIX Run-Time Utilities:

A sample listing of utilities furnished with the XENIX Run-Time System.

Appendix H. File Transfer Program (FTP):

Describes the file transfer programs that are used to transfer ASC II text or binary data files from an ACS 8000 MP/M system to an Altos 586 or ACS 8600 XENIX system, from a XENIX system to a MP/M system, or between XENIX systems.

DOCUMENTATION CONVENTIONS

All information the user enters is shown in **bold face**. Variable information is shown using these three small letters: n, a, and x. They mean, respectively, any number, any letter, and any character, either letter or number. For example:

#1 of n Version n.na Filename xxxxxx

The symbol <CR> means Carriage Return and refers to the Return key. Any designation inside < > refers to a key that does not display. When you see the symbol <CR> in bold face, you should press the Return key. For example:

Press <CR> Press <Space Bar> \$password <CR>

When you see the symbol <Control-D>, you should press and hold down the Control key and press the D key. For example:

\$ <Control-D>

All XENIX utilities and commands that are described in the text portions of this manual are underlined. For example:

The tar utility permits backing up . . .

OTHER INFORMATION AVAILABLE

This publication intends to be both concise and convenient--it introduces you to XENIX and helps you get started. There are other documents you may want to consult for more detailed information. Listed below are some publications on XENIX and UNIX.

XENIX Reference Card

A quick reference card is provided with the XENIX Run-Time System. It briefly explains how to log in and out, lists basic XENIX commands, and lists the Business Shell Menu selections. By accessing the Business Shell selections, you can use most of the XENIX utilities.

Altos Application Software User Guide

(The ABS Shell and application programs is an optional package.) The **Altos XENIX Applications Software Guide** provides information on how to install the optional ABS Menu Shell and the application programs, and how to access the ABS menus.

Altos UNET User Guide

(The communication network services is an optional package.) This document provides information on how to install the optional communication network services and how to use them.

Altos XENIX Development System Programmer's Reference Guide

(This documentation is provided only with XENIX development systems.) This document gives general information on the Altos release of XENIX, and detailed information of use to programmers.

The Guide includes reference and tutorial material pertaining to programs developed at the University of California, Berkeley, that are available in the Altos XENIX Development System.

UNIX Programmer's Manual, Seventh Edition

(This material is provided only with the XENIX development system.) This is a three-volume set (Volumes 1, 2a, 2b) published by Bell Laboratories. All users should refer to The Programmer's Reference book, which provides some tutorial material.

Commercially-Available Books:

A User's Guide to the UNIX System, by Thomas and Yates

(This book is supplied with your XENIX operating system.) It explains UNIX concepts and provides tutorials for getting started with UNIX and for implementing the most common commands. All of the utilities listed in the Thomas and Yates book are not provided with the XENIX Run-Time System. Refer to Appendix G, Sample Listing of XENIX Run-Time Utilities, for a listing of utilities provided with your system.

Using the UNIX System, by Gauthier

This book is more like a textbook than the Thomas and Yates' book. It presents a more in-depth explanation of UNIX, which is of value to the programmer and those who are already familiar with **A User's Guide to the UNIX System**.

Introduction To Operating 1 System Concepts

This chapter is directed to those with little or no exposure to computers and their operating systems. It briefly describes basic operating system concepts. For more information on operating system concepts and terminology, refer to one of the many commercially-available books on operating systems.

WHAT IS AN OPERATING SYSTEM?

An operating system is the master program of the computer system. The operating system keeps track of what is happening inside the computer. It supplies services for running and using your applications programs. It also controls the many resources of the computer, including the Central Processing Unit (CPU), memory, and peripheral devices, such as printers and terminals. It sends information to peripheral devices and receives information from them. The operating system also does general coordination and provides library services for keeping track of files. In addition, it supplies a large number of "utilities"--useful programs for doing various tasks--and provides methods for developing new programs.

Simple versions of operating systems, called "single-user" systems, allow only one person to use the computer at a given time. This makes the allocation of resources simple.

Systems that can serve two or more people (users) at separate terminals, such as XENIX, are called "multi-user" operating systems. These systems are necessarily more sophisticated than single-user systems because they must manage resources for many users. The multi-user system must determine ways to allocate resources efficiently and equitably.

The Central Processing Unit (CPU)--the "brain" of the computer that computes and manipulates data--runs incredibly fast. The input (what you enter at the terminal) and the output (the "processed" data that returns to your screen or is printed) are, by comparison, extremely slow. If a single program, or set of instructions, is run, the CPU is idle during data input and output. To maximize CPU efficiency, the CPU can start another program or process another inquiry while you are receiving the answer to your questions on the terminal.

The operating system coordinates many aspects of the system with which a user running a simple application is neither concerned nor aware. Different operating systems use different strategies for resource management, depending upon the design philosophy, computer structure, and user requirements. The crucial point is that all resources are managed by the operating system. A well-designed multi-user operating system runs in such a way that each user feels he or she is the only user.

WHAT IS A PROCESS?

When a request is made to your computer, the operating system attempts to subdivide the request into the smallest possible units with which it can work. This unit is called a process, or task. All of the work you perform on the XENIX system is carried out by processes. A process is a single sequence of events. Computer memory and files are accessed. A multi-processing, multi-user operating system allows one or many users to submit requests to the system to be processed in, what appears to be, a simultaneous manner. Actually, only one process is completed at a time, but it is completed so rapidly and the next process begun so quickly that it seems simultaneous. This subdividing into processes enables the multi-user operating system to handle diverse and simultaneous requests. You can receive input on your screen while someone else enters data and another person's program runs.

WHAT IS BOOTING?

"Booting" the system is a process that enables the computer to start operation. When the computer system is first started up (i.e., during installation or power up), there is no program running, nor is there one in memory. The first thing to be done is to get a program into memory. Unfortunately, the operating system program is on the disk, and the processor doesn't know where. So a program has to be put in the processor telling it how to get the operating system into memory. This program knows how to read in another program (a larger one), which in turn knows how to read in the operating system itself. This is called "bootstrapping" because it is as if the computer lifted itself up by its own bootstraps.

WHAT IS A COMMAND LANGUAGE?

Command languages enable you to communicate with the operating system. The UNIX shell is the command language for XENIX. The shell executes commands as you enter them at the terminal. These commands, usually one word, are the means by which you tell the computer what to do. To "speak" the language of your computer, you need to become familiar with its commands. The UNIX commands are described in Chapter 10, *Using XENIX on a Regular Basis*, and in **A User Guide to the UNIX System** by Thomas and Yates.

WHAT IS A COMMAND?

When you use a command language you must comply with rules that allow you to communicate unambiguously with the operating system. The operating system recognizes a given command, verifies the correctness or syntax of the command, and then organizes its resources to execute it. Generally, an operating system has a set of predefined commands which manipulate files (e.g., copy, delete, and move), execute application packages (e.g., word processor or accounting package), computer languages (e.g., BASIC), and monitor system status. Sometimes it is possible to define your own commands that execute operations you may use frequently. In Chapter 10, Using XENIX on a Regular Basis, you will find a description of some of the most frequently-used XENIX commands. Also, refer to **A User Guide to the UNIX System** by Thomas and Yates.

Examples of XENIX commands:

```
tar cv filename <CR>  
cd /usr <CR>  
who
```

WHAT IS A COMMAND FORMAT?

Generally, there are three parts to a command that you enter on a terminal: a keyword (the name of the XENIX command or program), a list of values or instructions (arguments), and a terminating character (you press the Return key). The keyword must be typed after the system prompt character: the # (super-user) or \$ (regular user) is used in XENIX. The prompt means that the system is ready to receive your commands. The command must be entered on the command line exactly as it appears in your manual or reference card. The command line consists of everything you enter after the system prompt and before you press the Return key. Each element (command, argument, or option) is separated by a space. The arguments and options must also be specified in an exact manner. For example, they may include file or program names, or special instructions that modify the command. Sometimes arguments are not required. Options may or may not be entered. All commands end with a carriage return. This tells the computer to process the information that has been entered on the line. There are other keystrokes for changing or deleting the command line. XENIX command formats are discussed in Chapter 10, *Using XENIX on a Regular Basis*, and in **A User Guide to the UNIX System** by Thomas and Yates.

Examples of the XENIX command formats:

tar cv filename <CR>

where:

tar = command to save and restore files and directories.

cv = options of tar command; directs the tar utility to save specified files and display a line on the terminal for each file backed up.

Filename = list files you want backed up or restored.

cd /usr <CR>

where:

cd = command to change directory.

/usr = new current directory.

who <CR>

where:

who = command to display all logged-in users.

WHAT IS A CONTROL CHARACTER?

When executing some program or command within the XENIX operating system, you are provided with a number of control capabilities through control characters. Such a sequence is activated by simultaneously pressing the control key on your terminal keyboard (usually labelled "CTRL" and sometimes denoted by ^) and an alpha character. For example, <Control-D> logs you out or interrupts the system. Refer to Chapter 10, Using XENIX on a Regular Basis, for a listing of the XENIX control character sequences.

WHAT IS A SYSTEM PROMPT?

When XENIX is ready to accept console input, it displays a prompt on the terminal. A dollar sign, \$, is displayed for regular users. A pound sign, #, is displayed for the super-user. After the prompt appears, you can enter commands on your terminal.

WHAT IS A UTILITY?

System utilities are programs that perform specialized tasks, such as copying a disk, printing files, setting time and date, etc. These stand-alone programs give the user greater file management capabilities. Some of the most-used system utilities in XENIX are described in Chapter 10, Using XENIX on a Regular Basis.

WHAT IS A FILE?

A file is a collection of information. It can be a program, the text of a letter, or financial data. A file can contain as much or as little information as you need.

A computer file is similar in concept to files stored on paper. A file can contain sales figures, a memo, or a list of customers. As with a standard manila folder file, you can keep almost any kind of information in a computer file.

You create files when you need to store information. For example, if you write a program, you'll create a file to hold it. If you need to store a customer list, you'll create a file. If you write a letter, you'll create a file.

Once the file is created, you can modify its contents using the word processor or text editor. The modified copy of the file usually replaces the original copy of the file unless otherwise specified.

Some basic facts about computer files:

- Files are stored on hard disks and floppy diskettes.
- The sizes of files vary. A file can be empty or so large that it fills the entire disk or diskette. A single file can overflow to other diskettes.
- A single disk or diskette can hold anywhere from one to tens or hundreds of files. The size of individual files is the most important factor for determining the number of files that a disk or diskette can hold.
- Each file on a disk or diskette must have a unique name. Files on different disks can share the same name.

The information in a file can come from several sources. The programs you buy are stored in files on diskettes. Many programs can create files. A word processor, for example, stores the text you write in files. And you can create files either by using the XENIX text editor(**ed**), or by copying another file.

XENIX gives you the tools needed to manage your files. Among other things, you can:

- List your files

- Display the file's contents
- Copy a file
- Erase a file

For more information on file concepts, refer to the XENIX File and Directory section in Chapter 2. For information on how to use files, refer to Chapter 10, Using XENIX on a Regular Basis.

WHAT IS A DIRECTORY?

Papers related to one subject can be placed in a manila folder file, or the information can be entered in a computer file. If you have a set of related file folders, you may decide to store them in a single drawer. In the XENIX operating system, a group of related computer files can be stored in a directory. For example, individual memo files can be placed in a directory called "Memo." The directory "Memo" can even have directories under it, for example: Memo.1, Memo.2, etc. Directories consist of files and other directories. The XENIX file system is arranged as a hierarchy of directories. Refer to the XENIX File and Directory Concepts section in Chapter 2, and to Chapter 3, Introduction to the Business Shell Menu System, for a discussion of directories.

WHAT IS AN EDITOR?

An editor is a program that enables you to create, view, and modify files. You enter text as you would on a typewriter. But instead of making corrections on paper or retyping, you can interact with the program and immediately revise your text. After saving the file, you can display it upon command.

The standard XENIX editor, ed, is a line-oriented editor. The distinction between line-oriented and full-screen editors, and editors and word processors is discussed in Chapter 11, Using the Ed Text Editor.

WHAT IS LOGGING ON AND OFF THE SYSTEM?

The term "logging on" (or "logging in") refers to the process by which you identify yourself to the XENIX operating system so you can use it to access your files. Logging on enables the system to protect your information from unauthorized use by others and sets up your account. You enter a secret password to gain access to your files.

The term "logging off" refers to the process whereby you complete your individual computer session. Your account is closed and your terminal is placed off-line.

Introduction To Xenix Operating System Concepts 2

This chapter describes XENIX operating system concepts. Basic operating system concepts are not described in this chapter. If you are not familiar with basic operating system concepts, read Chapter 1 before reading this chapter. Also, read through the glossary at the end of this manual.

WHAT IS XENIX?

XENIX is an operating system, which means that it supplies services for the application programs that run on your Altos computer system. Programs that provide word processing, or do accounting, or do "data base" services for information retrieval and reporting, are all grouped under the general name "application programs."

The services that an operating system such as XENIX supplies include sending information to peripheral devices and receiving information from them. ("Peripheral devices" refers to terminals, disk storage, printers, etc.) The operating system also does general coordination and provides library services for keeping track of files. In addition to this, the XENIX system supplies a large number of utilities, that is, useful programs for doing various tasks, and provides methods for developing new programs.

XENIX is furnished by Microsoft, Incorporated, and is based on Version 7 of the UNIX operating system, which was developed by Bell Laboratories. Altos has altered the original XENIX only in those ways which will improve its performance on the Altos hardware.

Some basic concepts are briefly explained below. For convenience in using this manual, many of the terms used here are also given in the glossary at the end of this manual.

Figure 2-1 accompanies this explanation of concepts.

Shells and the Kernel

The XENIX operating system is designed in layers. It can be thought of as somewhat like an onion; with the outermost layer being what is visible and touchable, and the inner layers supporting the outer ones. At the center is the "kernel" which deals with the hardware and with peripheral-dependant considerations and provides fundamental services for the outer layers.

The outermost layer is called, in UNIX, a "shell." The user works with the shell, giving it commands and asking it questions, and the shell calls on the lower layers to fulfill the requirements. As shown in Figure 2-1, the outermost layer actually has more than one shell. The ABS Menu Shell (the Altos Business Solution), makes use of the Business Shell, and the Business Shell is supported by the UNIX Shell.

The Altos XENIX operating system can be started up in the standard UNIX Shell, the Business Shell, or the ABS Shell if installed. Typically, when the Altos XENIX operating system is started up it opens in the ABS Shell or in the Business Shell if ABS is not available. There are commands for getting from one shell into another shell, although for many users there is no need to do so.

ABS (Altos Business Solution) -- Menu Shell

The Altos Business Solution is an optional group of software packages supported by the ABS Menu Shell and the Business Shell. These shells provide a framework for these programs and provide menus for controlling the computer system and directing the tasks you wish to have the system do. The shells also give help and tutorial information.

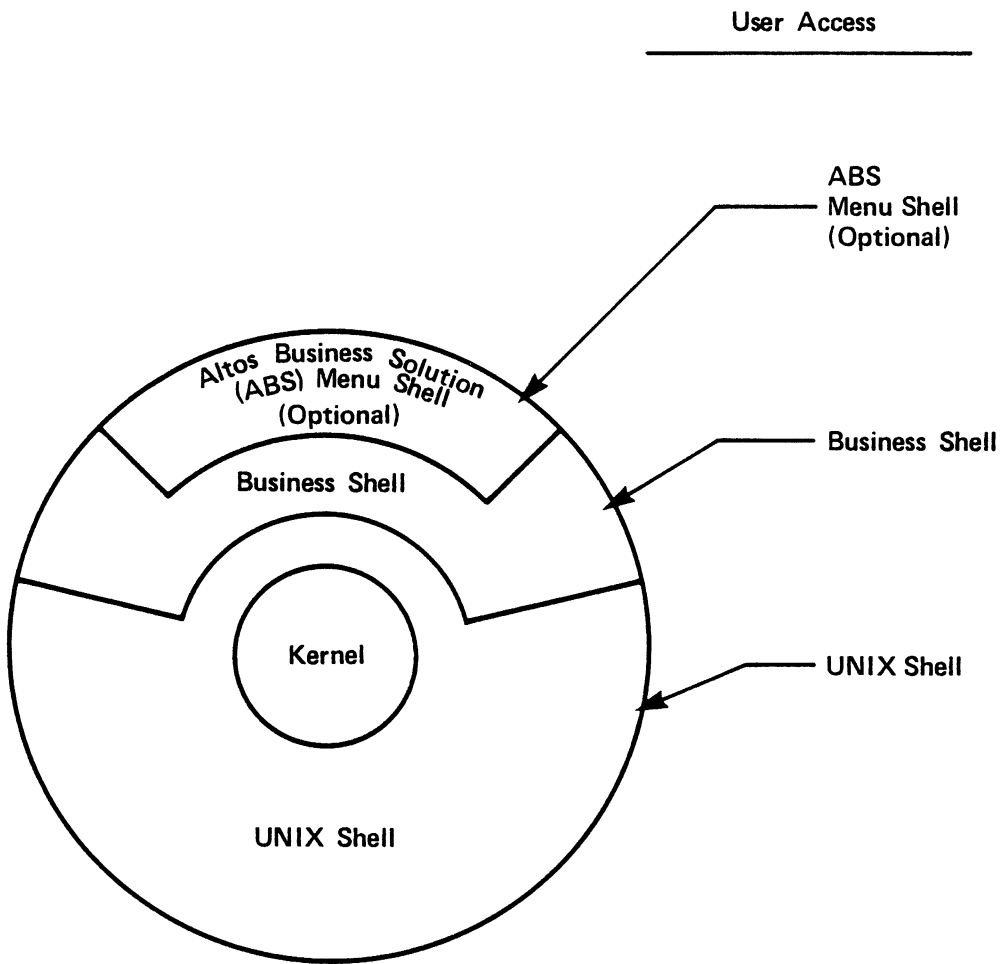

Depending on how your system is set up, you will begin operations up in one of these shells.

Figure 2-1. Design of Altos XENIX

Most of the application packages are also available from Altos separately. An Altos dealer may offer the Business Shell and the optional ABS Menu Shell with some of the ABS packages and some other software packages.

The Altos Business Solution has a complete set of documentation for the entire package. Refer to the **Altos XENIX Applications Software Guide** for more information on installing and using the ABS Menu Shell and its associated application programs.

BSH -- The Business Shell

The Business Shell provides a set of menus for calling up XENIX services, and optional application programs that may be installed by an Altos dealer or system developer. For every action that a Business Shell menu can call, there is corresponding help and tutorial information that can be seen on demand. BSH is the abbreviation for this shell.

The Business Shell enables the computer novice to have immediate and practical use of the system. The user can call on XENIX for services (utilities), such as backing up and restoring files, or sending messages to other users, without leaving the Business Shell.

For those users who want to learn about XENIX and begin to use it directly, the Business Shell provides a good foundation for exploration. After the Business Shell has taken you through a procedure a few times, you can try going into the UNIX shell and using that procedure directly.

When the ABS package or other application programs are provided, an optional main menu, called the Master Control Services, is installed via the ABS Menu Shell. When you log in as the system administrator (admin), the menu allows you to access the Business Shell XENIX services, the ABS or other software packages, and other services such as installing the software packages.

Further Information

Chapter 3 of this manual describes the Business Shell Menu System. Information on using the Business Shell and XENIX is provided in Chapter 10. The ABS or application software package is explained in a separate publication. Refer to the Other Documentation Available section in the preface for additional information on XENIX or UNIX.

XENIX FILE AND DIRECTORY CONCEPTS

This topic is discussed in greater detail in Chapters 1 and 3. Some basic concepts are given here for convenience in understanding some of the material in Chapter 10, Using XENIX on a Regular Basis.

A file in XENIX is much like an ordinary paper business file in a drawer or a file cabinet. A XENIX file is a collection of records, and a record could be broken down into transactions or field entries.

A XENIX file is "owned." The owner may be one of the system users, or several users who have the same "login id," such as the accounting department. The XENIX system itself owns certain files.

Directories and Subdirectories

Files are organized into directories. Actually, the organization is usually by subdirectories within directories, within other directories, and so on. Eventually, every file in your XENIX system can be traced from a starting point, the "root" or most fundamental directory, through various subordinate directories, to the actual file. See Figure 2-2 for example file system used in this section.

For example, a system user named John may have a number of files in his directory, which happens to be called /usr/john. His directory, /usr/john, is one of the user directories under /usr. Today John is working on a trip report. Using a word processor, he opens a file called "report.trip" and begins writing. The period in "report.trip" has no special meaning. John uses it as a convenience. He starts all his text files about reports with "report," and he uses a period to separate the rest of the identification.

When he is working in his directory, he simply refers to the file as "report.trip." From the /usr directory, it is john/report.trip. From another system directory, it is /usr/john/report.trip. (This name is called a "pathname." It gives the system a path to follow when looking for the file.)

John and other people in the Accounting Department might share other files that start with /usr/acct. For instance, there might be a category of files under the /usr/acct/payables directory, such as "expen.may" or "rents.jul" or "pettycash."

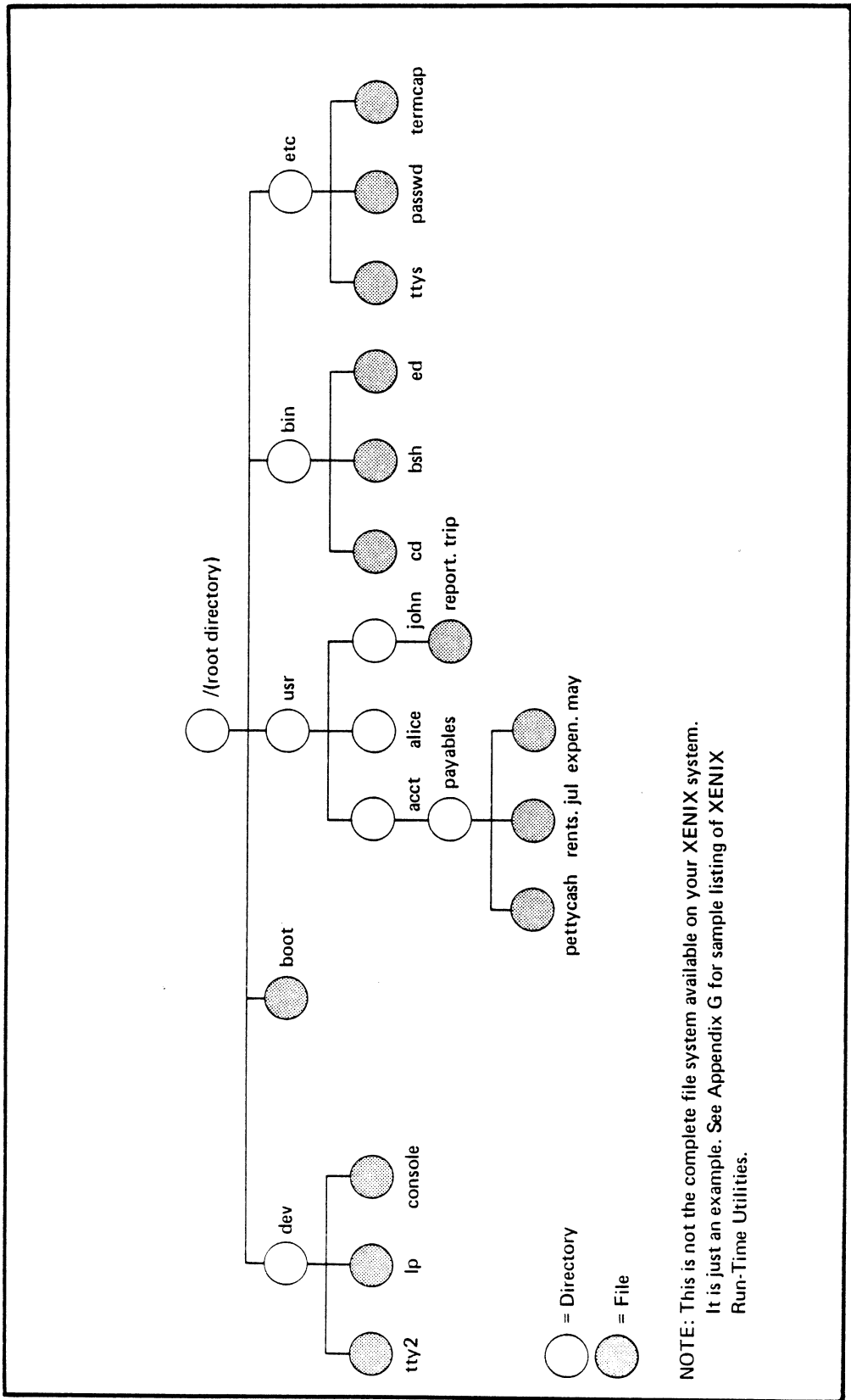

Figure 2-2. Example of XENIX Hierarchical File System

Attributes, Permissions, and Ownership

Files and directories have attributes and permissions that govern who can read them, modify them, delete them. Within the limitations of such permissions, a user may make use of many directories in the system for a variety of work. John and Alice, for instance, might share /usr/acct files but not /usr/john and /usr/alice files.

The Altos XENIX system comes with a large directory of prepared files, but these are system files and application program files that are used to provide user services. The actual user files are created by the user.

To change file characteristics, refer to the Business Shell menu selections that enable you to change file permissions, change file ownership, and change file group selections. More information on these functions is given in Chapters 3 and 10.

Limitations

The basic filename, such as "report.trip," is limited to fourteen letters. So when a file is specified by directories and subdirectories, as in:

```
/name1/name2/name3.../nameN
```

each name is not more than fourteen characters.

There is no formal limit to the size of the full pathname of a file; that is, to the number of subdirectories that may be involved in fully specifying a file starting from the most basic root file in the system. The only limit is that of practical use and system storage limits.

There are few limits on the characters that may be used in filenames. The one basic rule is that a space cannot be in a filename, because XENIX uses spaces to separate filenames in a list. There are other special characters that should not be used because they have special functions:

```
*      [      !      /  
,      ]      \     space  
?      ;      :
```

These characters are used for matching filenames when you want to treat a group of files together. For example, John could list all the names of his report files using "report.*." The asterisk means "match anything after the period." The question mark matches any one character. The brackets are used to list characters for matching.

SYSTEM CONFIGURATION

This section gives information on adapting your system to the terminals or printer you are connecting.

Terminals

If you have difficulty connecting a terminal to the system for installation, see Appendix D, Cables, Terminals, and Printer Interfaces, in the **Altos Operator's Guide**.

XENIX and the Business Shell can support a variety of terminals. The Business Shell makes use of special terminal capabilities.

Configuring Terminals for the Business Shell

The Business Shell contains a special procedure that asks you for information about the terminals installed on your system. Based on the information you give, the procedure adapts the Business Shell to make use of special terminal capabilities. The procedure is available from the System Administration menu in the business shell. It is called "The Port Configuration Utility." When application programs or the ABS package is provided, the procedure is also available from the Master Control Services menu in the ABS Menu Shell.

Printer

The standard printer is assumed to be a serial printer operating at 9600 baud and connected to serial port 6 for the 586 computer system and serial port 8 for the ACS 8600 computer system. If you need to change the baud rate, change the port location, or support additional printers on your XENIX system, see Appendix D, Serial Line Printer and Spooler. If you have a parallel printer, see Appendix E.

Introduction To The Business 3 Shell Menu System

INTRODUCTION

The Business Shell (or BSH) is a menu-driven package that runs under the XENIX operating system. It has been designed to allow you to use business application programs and utilities without the need to be especially knowledgeable of any computer languages or terminology.

A menu is a group of selections available to you at a particular level within the Business Shell. The selections display on the terminal. The primary advantage of a menu structure is its ease of use and the way it clarifies relationships of various parts of the Business Shell. For example, all utilities for backing up and restoring files from diskettes may be found in a menu especially for that purpose.

The programs within the standard Business Shell menu (Figure 3-1) are divided into two categories:

- 1) Basic Utilities - which perform fundamental operations on files and collections of files (called directories).

- 2) System and Help Functions - which include system administration, electronic mail service, running programs, network services, and quitting (logout). In particular, the Help function in this section provides tutorial and explanatory information about various functions and capabilities within the Business Shell.

Detailed discussions of each entry within the standard Business Shell menu are presented later in this chapter in two sections: Basic Utilities, and System and Help Functions. Figure 3-1 shows the full Business Shell menu that first appears when the package is invoked.

The Business Shell Menu System has been organized in a hierarchical fashion, which means that general functions contain more specific functions that in turn contain still more specific functions. This hierarchy is illustrated in Figure 3-2. Figure 3-2 also shows the optional ABS Shell Menu System and its relationship to the standard Business Shell Menu System.

Display Menus

The Business Shell contains Help menus for each of the menus in the system. To display a Help file for the menu in which you are working, simply enter **?<CR>**. This causes the Help description for the menu to be displayed. Here is a summary of the commands that give help information:

?<CR>	Help for current menu.
Name?<CR>	Help for the named menu (example follows).
Mail?<CR>	Help for the "mail" menu.
?index<CR>	Display an index of the available menus.

When asking for help for a named menu (**Name?<CR>**), the first letter of the name must be capitalized because a small letter might be interpreted by the system as meaning a menu selection. Menu item "r" (as shown in Figure 3-1) provides more information about the Help functions.

Fast-mode/Slow-mode

The Business Shell has two operation modes: fast-mode and slow-mode.

In the fast-mode, the system responds to a lower-case character by immediately executing the menu item associated with it. You do not need to press the Return key.

In the slow-mode, the system does not act upon a character or group of characters until you press the Return key.

In either mode, when you wish to enter a command that does not begin with a lower-case alphabetic character, such as ?, ??, or Name?, you must end the command with a carriage return.

The Business Shell is initially set (default) in the fast-mode. If you desire to change it, enter:

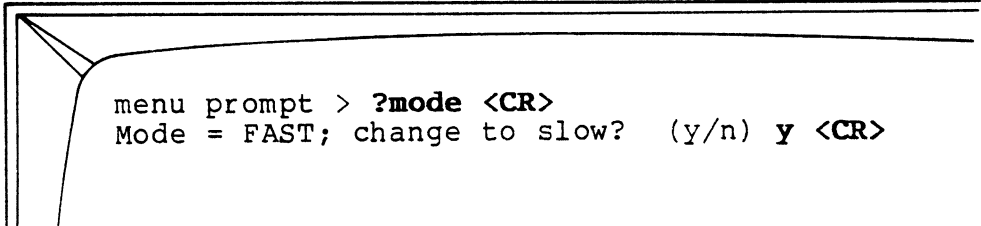

```
menu prompt > ?mode <CR>  
Mode = FAST; change to slow? (y/n) y <CR>
```

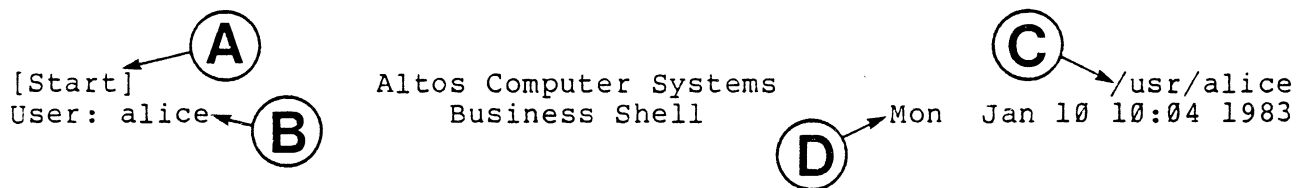

Basic Utilities

- | | |
|-----------------------|----------------------------|
| a. Change Directory | f. Edit a File (ed) |
| b. Change Password | g. Remove a File |
| c. List Directory | h. Copy &/or Combine Files |
| d. Create a Directory | i. Display Files |
| e. Remove a Directory | j. Print Files |

System and Help

- | | |
|--------------------------|---------------------|
| k. System Administration | n. Network Services |
| l. Electronic Mail | q. Quit (logout) |
| m. Run a Program | r. Help |

Type a letter to make your selection>

- Notes:
- A denotes the name of this menu.
 - B denotes the name of the current user.
 - C denotes the complete pathname.
 - D denotes the current date.

Figure 3-1. Business Shell Menu

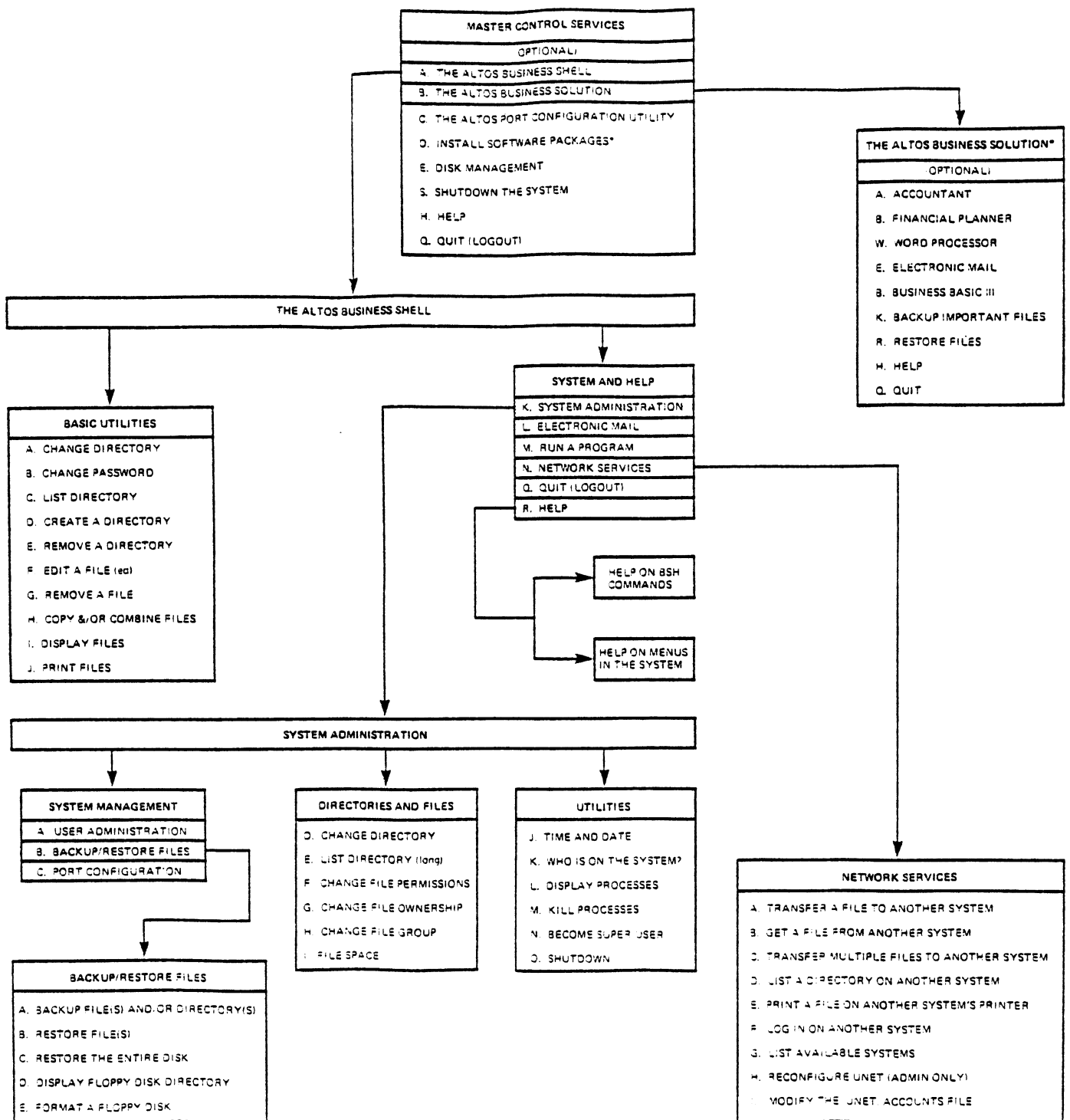

* Refer to XENIX Applications Software Guide for complete menus

Figure 3-2. Business Shell Organization

BASIC UTILITIES

The Business Shell utilities perform functions that are important in the daily operation of your system (see Figure 3-1). For example, the ability to determine the contents of file directories is provided. Since a significant portion of the utilities in this section pertain to files and directories, it would be useful to describe briefly these two concepts. A "file" may be thought of as a logical body of information with an identifying name. A "directory" may be thought of as a table of contents for a file system, designed to allow convenient access to specified files. An example of the directory structure is shown in Figure 3-3.

Change a Directory

This function allows you to change the current directory to a specified directory. When directory entries are displayed on your terminal, those that end with a slash (/) are, in fact, subdirectories within the currently active directory.

Change a Password

Allows you to change your password. A new password is requested. When the new password is entered, the characters are not echoed (do not appear) on the terminal. This prevents someone from seeing your password as it is entered. After you enter the password, the system asks you to retype it in order to verify that it has been entered correctly. The second entry must be identical to the first entry for the password to be changed.

List a Directory

Lists all file entries contained in the current directory.

Create a Directory

Creates a new directory.

Remove a Directory

Removes a directory and all files contained within it.

Edit a File (ed)

Creates or modifies a file using `ed`, the UNIX text editor. For an explanation of how to use `ed`, refer to Chapter 11, Using the Ed Text Editor and **A User Guide to the UNIX System** by Thomas and Yates.

Remove a File

Removes a file from a specified directory.

Copy &/or Combine Files

Creates copies of a specified file, or combines (appends) files.

Display Files

Displays the selected file on your terminal one page at a time. The "more" prompt at the bottom of the terminal screen gives you three options for continuing. Enter the required action as shown below:

Option	Action
Display the next line of text	Press the Return key
Display the next page	Press the Space Bar
Return to the first page of the file	Enter p

Print Files

Prints the specified file on the printer.

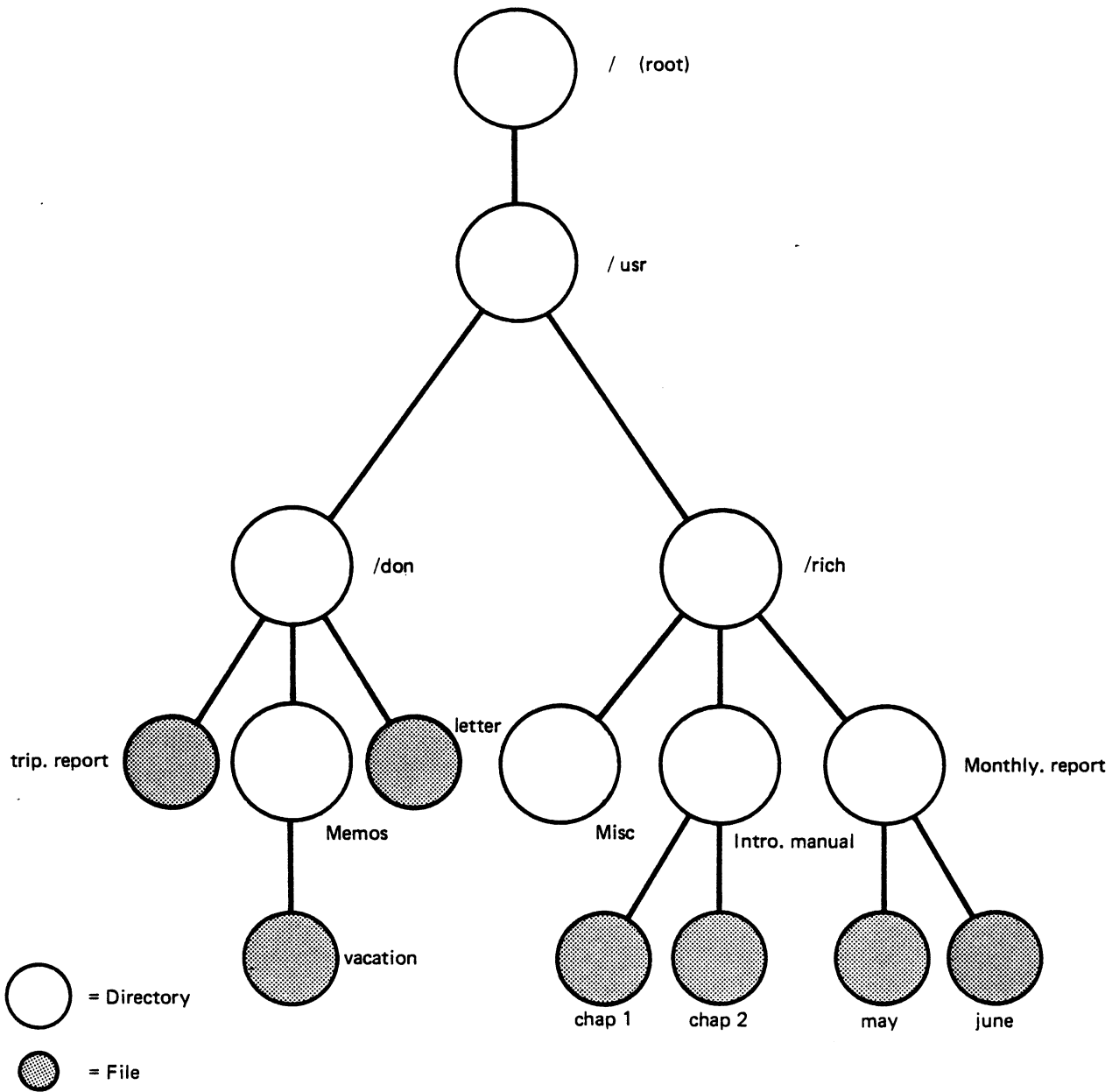

Note: Sample directories and files are shown next to bubbles

Figure 3-3. Directory Structure

SYSTEM AND HELP

This section contains the system management functions, utilities, and file utility commands. It also includes electronic mail, running programs, network services (optional), quit (logout), and help functions.

SYSTEM ADMINISTRATION

The function of this section, in general, is the management and coordination of system resources in a multi-user environment. See Figure 3-4 for an example of the menu. The menu is divided into three parts:

- 1) System Management -- contains system-related functions such as addition, deletion, and modification of user login information; backup and restore procedures; and port configuration (the pconfig program).
- 2) Utilities -- contains general utilities such as setting the time and date, displaying who is currently using the system, displaying the state of all current processes, system shutdown, etc.
- 3) Directories and Files -- contains all file and directory-related utilities, such as creation, deletion, renaming, showing file space in use, etc.

[SysAdmin]
User: alice

SYSTEM ADMINISTRATION UTILITIES
/usr/alice

System Management

- a. User Administration
- b. Backup/Restore Files
- c. Port Configuration

Utilities

- j. Time and Date
- k. Who is on the System?
- l. Display Processes
- m. Kill Processes
- n. Become Super User
- o. Shutdown

Directories and Files

- d. Change Directory
- e. List Directory (long)
- f. Change File Permissions
- g. Change File Ownership
- h. Change File Group
- i. File Space

What system administration function do you desire?>

Figure 3-4. System Administration Menu

System Management

The System Management section of the System Administration menu contains the following functions, as shown in Figure 3-4.

User Administration

This section discusses the control and administration of users on the system. This selection must be run by the system administrator (super-user). The following functions may be performed:

- show** Allows you to view an individual user, all users, a group, or all groups.
- add** Allows you to add a new user or group.
- delete** Allows you to delete a user or group.
- change** Allows you to change a user or group.

NOTE

Only the show command can be used on Users or Groups because you cannot make global changes, deletions, or additions to collections of users or to groups.

Examples of user and group listings are given below:

UID	USER NAME	GROUP	DIRECTORY	SHELL
0	root	other		
0	ruut	other		/bin/csh
0	admin	other		/bin/csh
1	daemon	other		
2	sys	sys	/usr/sys	
3	bin	bin	/bin	
4	uucp	uucp	/usr/spool/uucppublic	/usr/libluucp/
5	altos	other	/usr/altos	/bin/csh

GID	Group Name	Members
1	other	
2	sys	sys
3	bin	bin
4	uucp	

Backup/Restore Files

This section discusses file maintenance from the viewpoint of the system as a whole. The system administrator's primary responsibility is file backup and restoration.

The following submenu items appear on your terminal when you select the Backup/Restore function:

- a. Backup file(s) and/or directory(s)
- b. Restore file(s)
- c. Restore the entire disk
- d. Display floppy disk directory

Port Configuration

Allows you to configure the system for the terminals you plan to use. This lets some programs make use of special terminal capabilities. The program must be run by the system administrator, so log in as admin. After you run the port configuration program (pcon-fig), the system shuts down. The program prompts you as to whether you want to continue (shutdown) or to abort the process.

Utilities

The utilities section of the menu allows the system administrator to monitor system activities (See Figure 3-4). Processes--requests for system resources--such as application programs, utilities, or system programs may be examined or terminated. Certain commands, such as Time and Date or Display Processes, may be accessed by all users. Only the System Administrator (super-user) has the ability to execute commands that affect other users or could damage the system (i.e., shutting down the system).

The following submenu functions appear on your terminal when you select the utilities function:

Time and Date -- Allows you to check or reset the time and date.

Who is on the System? -- Shows you the other people currently using the system.

Display Processes -- Allows you to display the processes currently running on the system. This includes processes you have generated, the processes of other users, and system processes.

Kill Processes -- Allows you to cancel or kill the execution of a process currently running on the system. Note that anyone can kill his or her own processes but only the system administrator can kill another user's processes.

Become Super-User -- Allows you to become the super-user: this gives you full access to system routines and files as well as other privileges.

Shutdown -- Allows you to initiate an orderly shutdown of the entire XENIX operating system. You are asked to specify how soon the shutdown of the system should occur (from 0 to 15 minutes). After you enter a time, the system broadcasts a message to all users currently on the system announcing that shutdown will occur. A message is sent to each user at one minute intervals.

Directories and Files

This section contains additional functions that can be performed on the system. The functions are listed below:

Change Directory -- Allows you to specify another directory within which to work.

List Directory (long) -- Produces a detailed description of the files contained within the specified directory. An example of a directory listing follows:

```
Directory /usr/wilson
Total 1
-rwxrw-r-- 1 wilson 13341 Nov 1, 1982 myfile
```

Here is a brief explanation of the listing. The first dash designates this as a file. A "d" in that field designates a directory. The next nine locations designate the permissions for the owner, the group, and other users. The first three characters, "rwx", show that the owner can read, write and execute the file. The next three, "rw-", designate the group permissions; "-" means "no permission." The last

three, "r--", designate the permissions for anyone else wishing to access this file. See Change File Permissions below for a discussion of file usage options.

The file number and owner designation follows next; in this example, it is file 1 for "Wilson." (See the Change File Ownership section below for a discussion of file usage options.) The next field is the size of the file in bytes, 13341. The date field shows when the file was last modified. The last field is the name of the file.

Change File Permissions

Allows you to change a file's access permissions. There are three levels of access: owner, group, and other. Within each of these categories there are three types of access: read, write, and execute. An example of file permissions is presented above, under List Directory. Read permission allows reading the file; write allows writing (changing), or even deleting the file; and execute allows executing the file. For more information, see the `chmod` (change mode) command in **A User Guide to the UNIX System** by Thomas and Yates.

Change File Ownership

Allows you to change the ownership of a file. Note that you must be the system administrator to change ownership. See the directory listing provided above under List Directory.

Change File Group

Allows you to change the group designation of a file.

File Space

Displays the disk usage in blocks (512 characters per block). A period (.) in the name field denotes the current directory.

An example follows:

```
Free Blocks
/dev/root  49916
Disk Usage
6 .
```

Here is a brief explanation: /dev/root is the name of the complete file system for the primary disk. The number of available free blocks in the system is 49916. The current directory, specified by ".", uses 6 blocks. The directory includes all files and subdirectories within it.

ELECTRONIC MAIL

This application uses the standard UNIX mail utility to provide the capability for sending and receiving messages. Messages can be sent to and received from users on the system. For more information, see the discussion of mail in **A User Guide to the UNIX System** by Thomas and Yates.

RUN A PROGRAM

This entry contains three options for executing a program:

- 1) Execute the program in file "a.out"
- 2) Help on Running Programs
- 3) Run an Arbitrary Program

The help entry function, item #2, explains items #1 and #3.

Item #1 refers to a default file, called "a.out," that typically contains the results of the most recent compilation. For convenience, you can execute that program without having to provide a specific file name.

Item #3 allows you to run programs that already exist in the system (that is, reside within XENIX). The

programs may be purchased software packages or may be programs that you or someone on your staff has created.

To execute a program that resides within XENIX, simply enter the program name:

```
!program-name<CR>
```

Because many programs require some type of arguments or parameters, you can provide them after the program name.

```
!program-name parameters<CR>
```

The parameters are a string of values used by the program. For example:

```
!send -n afile bfile<CR>
```

NETWORK SERVICES

This selection under the Business Shell menu accesses the network services menu. See Figure 3-5 for an example of the network services menu. These optional network services allow communication between computer systems over a communication network. These services include transferring a file to another system, getting a file from another system, transferring multiple files to another system, listing a directory on another system, printing a file on another system's printer, logging to another system, listing available systems, reconfiguring UNET, and modifying the .UNET.accounts file.

For more information on how to use your communication network, refer to the **Altos UNET User Guide**.

QUIT (LOGOUT)

This function is used to exit from the Business Shell to the XENIX shell, or if your login shell is the Business Shell or the ABS Menu Shell, then the function logs you off the system.

[Network]

Network Services

- a - Transfer a file to another system
- b - Get a file from another system
- c - Transfer multiple files to another system
- d - List a directory on another system
- e - Print a file on another system's printer

- f - Log in on another system

- g - List available systems
- h - Reconfigure UNET (admin only)
- i - Modify the .UNET.accounts file

Select desired function>

Figure 3-5. Network Services Menu

HELP

Provides an explanation of the major functions within the Business Shell. The menu for this function is shown below.

The Business Shell allows non-computer professionals simple, rapid access to the full capabilities of Altos hardware without requiring them to become especially knowledgeable regarding the intricacies of the UNIX command language. The Business Shell is abbreviated as BSH when referred to on the menu screens.

TYPE

TO SEE

- a. A list of BSH commands
- b. A list of menus in the system

Information on commands and menus follows.

Business Shell Commands

The following commands are available in the Altos Business Shell. They are listed in response to entering "a."

COMMAND TYPE

SHORT EXPLANATION

prompt<CR>	Execute the function associated with the menu entry (for example, either a, b, or c).
Menu<CR>	Go to the named menu.
<return>	Return to the immediately preceding menu. By entering successive <return>s, you can retrace the path through the menus.
?<CR>	Show the help menu for the current display. The "?" by itself is the equivalent of entering <current menu>?. Returning from a help menu is accomplished in the same way as any other menu, by entering <return>.

COMMAND TYPE SHORT EXPLANATION

??<CR>	Display the command menu.
name?<CR>	Display help information for the named menu.
!command<CR>	The "!" causes immediate exit to the UNIX Shell. The rest of the line is executed in a sub-shell. An "!" alone initiates a sub-shell which is terminated in the normal UNIX manner <control-D>. By using "!sh," "!csh," or "!bsh" one may select the specific shell to be used; the standard UNIX Shell (sh), the optional C Shell (csh), or the Business Shell (bsh). See the Moving Between the Shells section in Chapter 10.
?index<CR>	Display the name of every menu in the current menu system. The "Dir" menu contains a short version of the index.
?mode<CR>	Set mode as either fast-mode or slow-mode.
Quit<CR>	Terminates the Business Shell or ABS Menu Shell, and returns control to UNIX (XENIX).

For more information, see the detail Help menus within the Business Shell by selecting r (Help). See Figure 3-1.

Business Shell Menus

The "b" response lists the menus in the system:

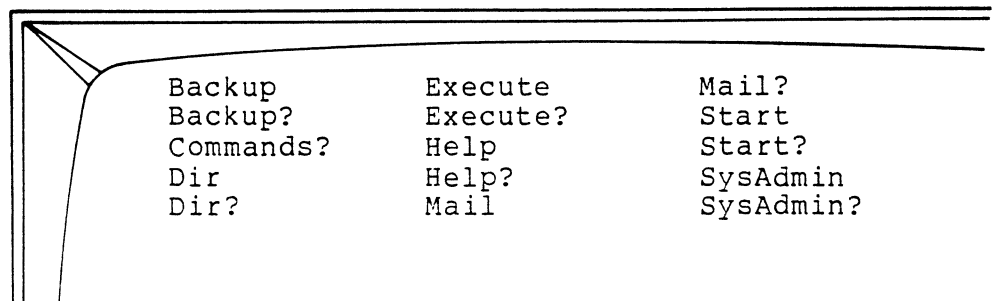

Backup	Execute	Mail?
Backup?	Execute?	Start
Commands?	Help	Start?
Dir	Help?	SysAdmin
Dir?	Mail	SysAdmin?

Introduction To System 4 Administration And Maintenance

System administration and maintenance involves ensuring system integrity, adding new users, maintaining adequate disk space, configuring ports for terminals and printers, saving and backing up files, bringing the system up and down when necessary, etc. The goal of system administration and maintenance is to make the system operate as smoothly as possible. The XENIX operating system provides tools that help in the day-to-day activities of such administration and maintenance. Some of the more useful tools are listed in this chapter. Most system administration and maintenance functions can only be performed by a super-user, as noted. Normally, the super-user is known as the system administrator.

ROLE OF THE SYSTEM ADMINISTRATOR (SUPER-USER)

Whether your XENIX operating system is single-user or multi-user, periodic system administration and maintenance tasks need to be performed. The person assigned to perform these various functions is known as the System Administrator, or Super-User. The system administrator should be assigned to port 1.

As the System Administrator, you are able to perform tasks that can affect system integrity and other users on the system. Exercise caution when using the super-user privileges.

The role of the System Administrator is to keep the XENIX operating system running as smoothly as possible. The responsibilities of the System Administrator include:

- o Installing and upgrading the XENIX operating system
- o Adding or changing user accounts
- o Checking and cleaning up files
- o Saving and backing up the file system
- o Managing disk space on the system
- o Displaying and killing processes
- o Configuring ports
- o Shutting down the system
- o Troubleshooting the system

These tasks are described briefly later in this chapter. Additional information on how to perform these tasks is provided in Chapters 7 and 10.

BECOMING SYSTEM ADMINISTRATOR AND SUPER-USER

You can become the system administrator by any of the following methods:

Port 1 should be assigned to the system administrator. When you install XENIX or power up the system, the system is brought up in the UNIX Shell (single-user mode) with the super-user prompt (#). From port 1, you can set the system up for multi-users. This protects the system by keeping regular users from accessing the super-user functions.

You can become the system administrator from any terminal by logging in as **admin** or **root**.

By logging in as **admin**, you start up in the Business Shell Menu (Figure 3-1), or in the Master Control Services Menu (Figure 7-1) if the ABS shell is installed. This method allows you to perform the super-user functions by using the menu system. If you are not familiar with UNIX or XENIX, it is better to log in as **admin**.

By logging in as **root**, you start up in the standard UNIX Shell with the super-user prompt (#). You have to perform some of the super-user functions in the UNIX Shell, such as running the **fsck** program. Be extremely careful when working directly in the UNIX Shell as the super-user.

You can become the super-user, which places you directly in the UNIX Shell, from the Business Shell Menu System, by selecting letter **n** under the System Administration menu (Figure 3-4). This allows you to run super-user programs, such as **fsck**, and then return to the Business Shell by pressing the Return key.

You can also become the super-user without logging out of your user account by entering **su <CR>** from the UNIX Shell or **!su <CR>** from the Business Shell. When you have finished the desired super-user function, you can return to your user account by pressing the Return key.

PROTECTING SYSTEM ADMINISTRATOR AND SUPER-USER LOGIN NAMES

To maintain system security, you should immediately assign passwords for the super-user login accounts (admin and root). Setting passwords for admin and root, means that you are required to enter a password when using the su command. You are prompted for a password.

For more information on setting and changing passwords, refer to Chapter 9, Log In, Log Off, and Quit.

Installing the XENIX Operating System

Installing the XENIX operating system for the first time is the first responsibility of the system administrator. After the operating system is installed and file systems checked, it is brought up for multi-user operation. Refer to Chapter 5, *Installing XENIX*, for step-by-step installation instructions.

Upgrading the XENIX Operating System

Installing upgraded versions of the XENIX operating system is also the responsibility of the system administrator. It is important to install the new versions without affecting existing user account files on the hard disk. Refer to Chapter 6, *Upgrading Older Versions of XENIX*, for step-by-step instructions.

Adding or Changing User Accounts

Adding users to the system or changing their characteristics is done with an interactive program named ua. The ua program provides an effective means for maintaining the system password (`/etc/passwd`) and system group (`/etc/group`) files. To use the ua program, you must be logged in as super-user (root, admin, or via the su command).

You can run the ua program from the Business Shell by entering **k** to access the System Administration menu, and then by entering **a** to access the User Administration program.

You can run the ua program from the UNIX Shell by entering **ua <CR>**.

Refer to the *Creating and Changing User Accounts* section in Chapter 7 for more information concerning adding or changing user accounts.

Checking and Cleaning up Files (fsck)

The fsck program audits and interactively repairs inconsistent conditions for the named file systems. If the file system is consistent and checks out as good, then the number of files, number of blocks used, and number of blocks free are reported. If the file system is inconsistent (i.e., bad disk sectors), you are prompted for concurrence before each correction is

attempted. You should answer "Yes" to all prompted questions. Most corrections lose data; all losses are reported.

The `fsck` program should be run at the first hint of a file system problem: for example, when commands are not executing properly.

The system administrator should run `fsck` program on a regular basis; at least once a day.

To use the `fsck` program, enter the following:

From the Business or Optional ABS Shell:

```
menu prompt> !fsck /dev/root <CR>
```

From the UNIX Shell:

```
# fsck /dev/root <CR>
```

To use the `fsck` utility on a system configured with a 40-megabyte hard disk system, you must specify the file name (`/dev/rhd0.roc0`). For example, enter:

```
# fsck -t /dev/rhd0.roc0 /dev/root <CR>
```

For examples of when and how to run the `fsck` program, refer to Chapter 5, Installing XENIX, and the Recovering From Improper Shutdown section in Chapter 8. Also, for more information on how to use `fsck` with its available options, refer to the Checking and Cleaning Up Files section in Chapter 10.

Saving and Backing up the File System (tar)

You should back up the file system on your hard disk regularly (i.e., once a day). Anyone can back up files on an individual basis, but it is recommended that the system administrator back up the whole file system.

Backing up your files is essential in case you have a power failure, major disk error, etc. It allows you to recover data that may otherwise be lost because of major emergencies.

The tar utility permits the backing up and restoring of single files and whole directories. subdirectories are included, to whatever depth the user wishes.

Managing Disk Space on the System

Managing disk space is one the primary responsibilities of the system administrator. The system administrator needs to keep track of the available space on the computer system's hard disk, and how much space is being used by each user.

The du program displays how much disk space is being absorbed by each user. The df program displays how much disk space is available. It is recommended that you run these programs at least once a day. If you run out of disk space, perhaps because you are running a lot of processes, you could lose what you are working on, or worse, get to a point where you can't clean up the disk space. If the latter occurs, you have to re-boot.

If you are consistently reaching 100 blocks of available space, you should consider obtaining additional space by deleting no longer used files or by ordering an additional hard disk.

NOTE

The du and df commands are informative commands only. To remove files or directories, refer to the appropriate selection under the Business Shell. To remove (kill) active processes, refer to the appropriate selection under the Business Shell.

The Business Shell allows you to display the number of free blocks (512 characters per block) as well as the disk usage per user. Select **k** under the Business Shell menu (Figure 3-1) to access the System Administration menu (Figure 3-4). Then select **i** to access the File Space selection.

To use the df and du programs directly from the UNIX Shell, enter:

```
# df <CR>
# du <CR>
```

For more information on these programs, refer to Chapter 10, Using XENIX on a Regular Basis, and **A User Guide to the UNIX System** by Thomas and Yates.

Displaying and Killing Processes (ps, kill)

All processes on the system are assigned a process identification (PID) number. PID numbers are displayed by using the ps command or by selecting the Display Processes menu selection (l) under the System Administration menu of the Business Shell.

Occasionally, a program may go awry; it may loop forever, lock up your terminal, or in general, behave badly. If this happens, you should identify the process causing the problem by using the ps command (or by selecting Display Processes (l)). Then kill that process by using the kill command or by selecting Kill Processes (m) under the System Administration menu of the Business Shell. If you are not certain which processes are causing a problem, don't kill any process--seek help.

NOTE

Do not kill the init, cron, and the swapper processes. These processes must continue to run if the system is to operate properly.

For additional information, refer to Chapter 10, Using XENIX on a Regular Basis, and **A User Guide to the UNIX System** by Thomas and Yates.

Configuring Ports (pconfig)

Once the XENIX operating system is installed, the system administrator must configure the ports for the various terminals and printers connected to the computer system.

The port configuration (pconfig) program is an interactive program used to configure terminals and printers for the system. It must be run by the system administrator.

To access this program, log in as **admin** and select Port Configuration (c) under the Master Control Services menu (Figure 7-1), or under the System Administration menu (figure 3-4). You can also access this program directly from the UNIX Shell by entering:

```
# pconfig <CR>
```

For more information, refer to the Configuring the Ports section in Chapter 7.

Shutting Down the System (shutdown, haltsys)

When bringing the system down, usually to install a new system, or for maintenance, the /etc/haltsys (single-user), or /etc/shutdown (multi-user) programs should be run by the system administrator. The system administrator must be logged in on port 1 to shut down the system. The shutdown program warns other users that the system is going down. The haltsys program brings the system down without warning.

To shut down the system from the Menu System, select the Shutdown the System selection under the Master Control Services menu (Figure 7-1), or under the System Administration menu (Figure 3-4) of the Business Shell.

To shut down the system from the UNIX shell, enter:

For multi-user systems:

```
# /etc/shutdown <CR>
```

For single-user systems:

```
# sync <CR>
# /etc/haltsys <CR>
```

For more information on shutting down the system, refer to the Shutting Down XENIX section in Chapter 10.

Troubleshooting the System

If you perform daily preventive maintenance procedures, such as checking and cleaning up files, saving and backing up files, managing disk space on the system, and monitoring processes, your XENIX operating system should run smoothly.

However, emergencies do occur--such as a power failures, someone accidentally pressing the Reset button --causing the system to reset and shutdown improperly, or someone is "hung up" in a application or system program and can't exit.

The XENIX operating system displays English-syntax error messages to indicate problems to the console. Additional messages may also be available from the individual application programs that you have installed.

Some errors, such as illegal commands entered, are simple errors which an individual user can solve. Others, such as bad sectors on the hard disk, may require the running of Altos diagnostics.

If the problem persists, and you have tried all of the available maintenance tools listed in this chapter, try shutting down the system and running the fsck program. If you still cannot fix the problem, get help.

Installing Xenix 5

This chapter provides instructions for installing the XENIX operating system onto your Altos 586 or ACS 8600 computer system. This procedure erases all previous information on your hard disk. You will most likely use this procedure immediately after purchasing your computer system when you first install XENIX onto your hard disk. Once you have installed the XENIX operating system and desire to upgrade it to a later version of XENIX, use the procedures provided in Chapter 6.

PRIOR STEPS

Before you install XENIX, you must:

1. Run the system diagnostics. For instructions, see the **Altos Diagnostic (ADX) Guide**.

When the disk diagnostics are run, if any bad sectors are found on the hard disk that have not been flagged (i.e., marked off) they must be flagged using the procedures described in that manual. The XENIX installation procedure automatically handles any bad sectors that have been flagged, making sure not to store data in bad sectors.

2. Make copies of the XENIX installation diskettes, and hand-copy the label information. Store the originals in a safe place.

The ADX diskette has a copy utility that can be used. See the **ADX Guide** for information.

Before starting the installation procedure, assemble the copied set of XENIX installation diskettes. There are several installation diskettes, labeled as follows:

1. XENIX Root File System
2. XENIX Run-Time Utilities #1 of n

NOTE

The Altos 586 XENIX Run-Time System has two diskettes. The ACS 8600 XENIX Run-Time System has three diskettes.

3. XENIX Run-Time Utilities #2 of n
4. XENIX Development System Utilities #1 of n
5. XENIX Development System Utilities #n of n

NOTE

If you have the XENIX Development System, you will also receive additional diskettes, such as the C compiler. See the XENIX Development System Programmer's Reference Guide for more information.

If you are not familiar with handling floppy diskettes, read the Handling Diskettes chapter in the

Operator's Guide. It covers preventing data loss when working with diskettes, and proper storage of diskettes.

If you experience system errors during installation, call your Altos dealer or Altos Field Engineering.

PROCEDURE FOR INSTALLING XENIX

During the installation process, you are queried on the screen for certain information, such as the size of your hard disk. Based on your answers, the XENIX operating system is configured to your specifications.

Allow half-an-hour to an hour to install the XENIX operating system for the first time. As you become familiar with this procedure, installation takes less time. Should you stop the installation in progress, the next time you work with the system a message indicates the system was not shut down properly. In this event, refer to the section, Resuming Interrupted Installation.

Errors made when entering the installation procedure can easily be corrected. Correct a single character error by pressing the Backspace key. Erase a line with the Rubout or Delete key.

Step-by-step installation procedures follow:

NOTE

THE ACS 8600 computer system is equipped with a Reset button on the front panel. The Altos 586 computer system may or may not be equipped with a Reset button on the front panel.

If your system does not have a Reset button, instead of pressing the Reset button, momentarily set the ON/OFF Power switch to OFF on the rear panel of your 586 computer system.

1. Be sure that the terminal is plugged into serial port 1 at the back of your Altos computer system.

NOTE

Port 1 is designated as the console. It should be used by the system administrator (super-user). When you install XENIX, or shut-down and power-up the system again, the system is brought up in the UNIX shell (single-user mode) with the super-user prompt. From port 1, you can set the system up for multiple users. This protects the system by keeping regular users from accessing the super-user functions.

2. Turn on the power switch. You will see the monitor sign-on message.

```
PASSED POWER-UP TEST
ALTOS COMPUTER SYSTEMS - 586 (or ACS 8600)
Monitor Version n.nn
```

```
Press any key to interrupt boot
```

```
Disk Boot Failed, Code: xx
*
```

The error message appears because there is no operating system on the hard disk. The monitor goes to the hard disk looking for information. Note that the system may respond with "Booting from Hard Disk" instead of the error message. The results are the same.

NOTE

ACS 8600 systems with EPROM Version 1.5 will try to boot automatically from floppy diskette. Since there is no floppy diskette in the drive, the results are the same.

ACS 8600 systems with EPROM Version 1.6 will try to boot automatically from the hard disk.

3. If you **do not** get the monitor sign-on message, look in the **Altos Operator's Guide** for the Appendix on "Cables, Terminals, and Printer Interfaces," and check that your console is properly set up and attached to the computer system.
4. Press the **Reset** button on the front panel, and prepare to press the **Space Bar** key as soon as you see this message:

```
PASSED POWER-UP TEST
ALTOS COMPUTER SYSTEMS - 586 (or ACS 8600)
Monitor Version n.nn
```

```
Press any key to interrupt boot
<Space Bar>
```

If you press the Space Bar key in time, you will see the display in Step 5. If not, try again.

5. When you see the following display, insert the diskette labeled "XENIX ROOT FILE SYSTEM" and enter 2 to "boot" from the floppy diskette.

NOTE

The diskette must be enabled for writing; that is, the computer system must be able to place information on it. If the diskette is write-protected, the system will give you a message. Consult the Diskette Handling chapter in the Operator's Guide.

586 Display:

```
Enter (1) to boot from Hard Disk
Enter (2) to boot from Floppy Disk
Enter (3) to enter from Monitor
```

```
Enter option: 2
```

8600 Display:

```
Enter (1) to boot from Hard Disk
Enter (2) to boot from Floppy Disk
Enter (3) to boot from Tape
Enter (4) to boot from Diagnostics
Enter (5) to enter Altos monitor
```

```
Enter option: 2
```

After a delay of 35-40 seconds, the following message appears.

```
586 (or ACS 8600) Xenix vn.na
mem = nnnK
#
```

The "#" is the XENIX prompt for the super-user. XENIX is ready for your commands.

6. Enter **fsck /dev/root<CR>**

This command causes the system to check that the file system on the floppy diskette is good before installing it.

```
# fsck /dev/root<CR>
/dev/root
** Phase 1 - Check Blocks and Sizes
** Phase 2 - Check Pathnames
** Phase 3 - Check Connectivity
** Phase 4 - Check Reference Counts
** Phase 5 - Check Free List
nn files nn blocks nnn free
#
```

7. If Step 6 is not successful, the "XENIX ROOT FILE SYSTEM" diskette is defective and must be replaced. Start over at Step 4 with a new diskette.

If Step 6 was successful, enter **make.hd<CR>**. This command prepares the hard disk.

```
||| # make.hd<CR>
```

For the 586:

You will not be prompted for the hard disk size; therefore, no reply is needed.

For the 8600:

```
||| What size disk do you have (20, 40)?
```

For the 8600, the question refers to the size of the hard disk. The "dash number" at the end of the model number shows the size: -12 means 20 and -14 means 40.

8. For the 8600, we will reply with 20, for example. For the 586, no reply is needed. The system begins to prepare the hard disk for XENIX.

```
# 20 <CR>
```

```
Checking block nnnnn
```

```
.
```

```
Checking block nnnnn
```

The computer system takes 10-15 minutes for this step, and gives messages about what it is doing.

It may find disk sectors that the diagnostic program has flagged. The flag means the sectors should not be used, so the system reassigns that location. If this happens, it gives a message similar to:

```
err on dev 0/0  
bn = xxxx  cmd = xxxx  sts = xxxx
```

```
Block nnnn is bad  
Continuing on block nnnn+1
```

You may also see messages of the form:

```
Spare block nnnn is also bad
```

if there is a bad spot in the alternate location. These messages are for information only, and do not indicate any problem.

After 10-15 minutes, when the preparation process is complete, XENIX displays the map for alternate locations.

The following message is then displayed:

```
isize = xxxxx  
m/n   = x xx
```

After several minutes, you will see:

```
/dev/hd0b
** Phase 1 - Check Blocks and Sizes
** Phase 2 - Check Pathnames
** Phase 3 - Check Connectivity
** Phase 4 - Check Reference Counts
** Phase 5 - Check Free List
nn files nnn blocks nnn free
2 + 0 records in
2 + 0 records out
```

```
Now boot the hard disk and run 'load.hd' to
get the rest of the utilities.
** Normal System Shutdown **
```

You may see the error message:

```
***** FILE SYSTEM WAS MODIFIED *****
```

This indicates that you have bad disk sectors and the system has made necessary adjustments.

NOTE

If you see any error messages other than those described above, your hard disk has not been initialized correctly. Try repeating the installation process from the start. If this does not work, consult your Altos Dealer or call Altos Customer Service.

9. So far, so good. The "XENIX ROOT FILE SYSTEM" is installed on the hard disk. Remove the "ROOT FILE SYSTEM" diskette to a safe place.
10. Press the **Reset** button. Do not press any key when prompted. The system will read information from the hard disk, and, after a delay, give the XENIX display. This procedure "boots" (starts) the system) from hard disk. Go to Step 12.

NOTE

If your ACS 8600 system is not equipped with EPROM Version 1.6, you should interrupt the automatic boot cycle by pressing the Space Bar when prompted (press any key to interrupt boot). If you are not sure which EPROM Version you have, press the Space Bar and go to Step 11.

```
PASSED POWER-UP TEST
ALTOS COMPUTER SYSTEMS - 586 (or ACS 8600)
Monitor Version n.n.n

Press any key to interrupt boot
```

- 11. If you did happen to press a key, you will see the message below. If that happens, you can enter 1 to "boot" from the hard disk.

586 Display:

```
Enter (1) to boot from Hard Disk
Enter (2) to boot from Floppy Disk
Enter (3) to enter from Monitor

Enter option: 1
```

8600 Display:

```
Enter (1) to boot from Hard Disk
Enter (2) to boot from Floppy Disk
Enter (3) to boot from Tape
Enter (4) to boot from Diagnostics
Enter (5) to enter Altos monitor

Enter option: 1
```

After a delay of about 15 seconds, the XENIX display appears.

```
586 (or ACS 8600) Xenix vn.na

mem = nnnk
#
```

- 12. When you see the XENIX prompt (#), enter **load.hd<CR>**.

```
586 (or ACS 8600) Xenix vn.na

mem = nnnk
= load.hd<CR>
```

13. At this point, you have a basic XENIX operating system on the hard disk, and are going to load the rest.

The procedure continues:

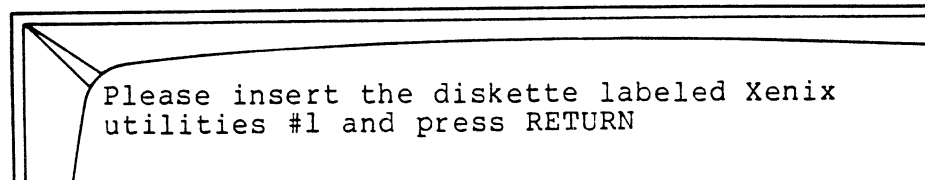

Please insert the diskette labeled Xenix utilities #1 and press RETURN

14. Insert the diskette labeled "XENIX RUN TIME UTILITIES #1" and press the **Return** key.

As files are copied from diskette to hard disk, you will see messages of the form:

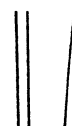

x "filename", nnnnn bytes, nn tape blocks

You will also see messages saying that a file has been linked to another file. These messages are for information only.

NOTE

Do not remove the diskette until prompted by the system to remove the diskette.

The ACS 8600 Run-Time system has two Run-Time utility diskettes. After the files are transferred from the first diskette to the hard disk, the system prompts you to load the remaining run-time utility diskette. When you see the prompt message, remove the first Run-Time utility diskette, insert the second utility diskette, and press the **Return** key. Store the first Run-Time utility diskette in a safe place.

After the last file has been copied to hard disk from the diskette, the display of filenames stops. You will see the message,

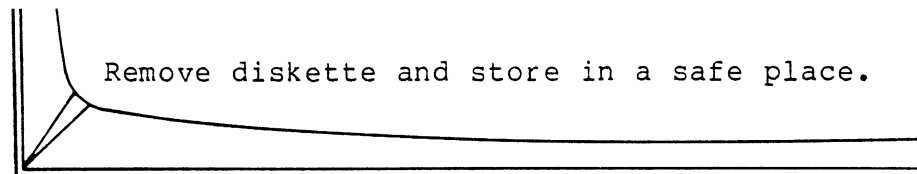

Remove diskette and store in a safe place.

15. Remove the Run-Time utility diskette and store it. Meanwhile, the system is doing several minutes of internal processing. Do NOT do anything with the system until you see the prompt "#."

NOTE

Be sure this prompt has appeared before you continue with the next step.

16. When you see the prompt character, #, enter

```
# fsck /dev/root<CR>
```

This command causes the system to validate the consistency of the file system on the hard disk. It is the final check of the installation.

```
# fsck /dev/root<CR>
/dev/root
** Phase 1 - Check Blocks and Sizes
** Phase 2 - Check Pathnames
** Phase 3 - Check Connectivity
** Phase 4 - Check Reference Counts
** Phase 5 - Check Free List
nn files, nnn blocks, nnn free
#
```

This indicates that XENIX has been successfully installed. If you see errors other than those mentioned above, return to step 11 and perform the **load.hd** procedure again. You may prefer to use another copy of the set of installation diskettes.

Remember, if during your installation you see a message saying the "system was not shut down properly," consult the Resuming Interrupted Installation section.

17. If the previous steps were successful, your XENIX Run-Time System is correctly installed.

If you purchased the XENIX Development System, refer to the **Altos XENIX Development System Programmer's Reference Guide** for the additional steps required for installing the XENIX Development System.

If you purchased Altos communication network services, refer to the **Altos UNET User Guide** for information on how to install the communication network services.

If you purchased the ABS package or other software packages, refer to the **Altos XENIX Applications Software Guide** for information on how to install the ABS Menu Shell and the application programs.

It is best to configure the ports and add login user accounts before going multi-user. Refer to Chapter 7, Getting Started with XENIX.

If you wish to start XENIX up, see Chapter 8, Starting Up XENIX. If the system has not been shutdown, skip steps 2 and 3 of the Starting Up XENIX procedure.

If you don't plan on using your XENIX system at this time, you can shut the system down by entering:

```
# sync <CR>
# /etc/haltsys<CR>
** Normal System Shutdown **
```

RESUMING INTERRUPTED INSTALLATION

You may receive the following message because you had interrupted the installation procedure, or your system was shut down by a power failure or a system crash:

```
The system was not shut down properly, and
the root file system should be cleaned.
Proceed (y/n)?
```

2. ALWAYS enter y.

XENIX validates the consistency of the disk file system, which may have been damaged, and automatically repairs it. If there is no damage, you will see the following output:

```
Proceed (y/n) y <CR>
/dev/root
** Phase 1 - Check Blocks and Sizes
** Phase 2 - Check Pathnames
** Phase 3 - Check Connectivity
** Phase 4 - Check Reference Counts
** Phase 5 - Check Free List
nn files nnn blocks nnn free

root structure was ok - proceeding with
bootup
#
```

The "#" prompt sign shows that all is well.

If the file system was damaged, XENIX repairs it automatically and displays a log of the necessary corrections.

3. If you have any doubt whether the file system has been repaired satisfactorily, we recommend you start over with a new set of installation diskettes.

NOTE

You can use the ADX (diagnostics) program to verify that the system is okay. See the ADX Guide.

For more information, refer to the description of the fsck program, which is described in the Checking and Cleaning Up Files section in Chapters 4 and 10.

Upgrading Older Versions of Xenix 6

This chapter provides instructions for installing a newer version of the XENIX operating system over an older version. For initial installations, use the procedure provided in Chapter 5.

The procedure for installing an updated XENIX version depends on the release you have and the release you want to install. See Table 6-1.

Table 6-1. Overview of Upgrade Procedures

IF YOU HAVE	WISH TO INSTALL	USE PROCEDURE
ACS 8600:		
2.0a - 2.0c	Any version	A
2.2a - 2.2c	2.2a - 2.2c	A
2.2a or later	2.2d	B
ALTOS 586:		
Any version	Any version	B

On XENIX Versions 2.0a through 2.0c for the ACS 8600, files are laid out on the hard disk in a manner that is not compatible with Version 2.2a and later versions. By following Procedure A, this incompatibility will be resolved. The new layout allows the assignment of alternate sectors for bad sectors, and is a major system enhancement.

Procedure A also enables the installation of XENIX Version 2.2a or later, while preserving user files from the prior version. The following tasks will be accomplished:

1. The hard disk layout will be restructured.
2. Earlier system files will be replaced by new files of the same name.
3. User files (i.e, non-system files) will be preserved.

NOTE

If XENIX Version 2.2a or later is simply installed on top of a prior version, all existing files are destroyed.

Further information is available in the **Altos XENIX Development System Programmer's Reference Guide**. (See the LAYOUT(1) and MAP(1) Utilities.)

PROCEDURE A

Overview of Procedure A

In brief, the procedure is to:

1. Log in as super-user (root).
2. Copy the relevant parts of the system to backup diskettes using the tar utility. (See the Saving and Restoring Files section in Chapter 10.)
3. Follow the regular installation procedure (described in the preceding section) from the beginning.
4. Copy the backup diskettes back to the hard disk using the tar utility.

The result is: Where new files have the same file name as prior files, the new files replace prior files. Where the file name of prior files is unique, as with user libraries, those files remain.

The number of single-sided, double-density floppy diskettes required depends on how full the hard disk is. The approximate maximum for a fully-loaded hard disk is:

1. Approximately 10 diskettes for a 10-megabyte hard disk (586 system).
2. Approximately 35 diskettes for a 20-megabyte hard disk (8600 system).
3. Approximately 74 diskettes for a 40-megabyte disk (8600 system).

Copying requires approximately three minutes per diskette. The number of diskettes and the total time depends on the size of your file system.

Detailed Installation for Procedure A

1. Log in as super-user on the system console, in single-user mode. This is done by entering the name "root."

```
login: root<CR>
```

If necessary, use the wall utility to ask other users to log off. To use the wall utility, enter:

```
# cd /etc <CR>
# wall <CR>
enter message <CR>
<Control-D>
```

The who utility informs you if any others remain. Do not proceed until you are the sole user. To use the who utility, enter:

```
# who <CR>
```

2. Copy all subdirectories of the root directory, except /dev. The root directory is designated by the slash (/). Use the tar utility. A typical command for this is:

```
# cd /<CR>
# tar cvs 900 usr<CR>
```

If you installed your own programs in /bin (which you should not have), or have files for some reason you want to save in temp, be sure to copy these also. Remember to save such files as /etc/passwd or termcap if you modified them in a way you want to preserve. Be sure to label and number each diskette in order as you unload it.

3. Follow the regular installation given in the preceding section. After you finish Step 17 of the normal installation procedure, return and complete Step 4.
4. Restore the saved files from the floppies:

```
# cd / <CR>
# tar xv<CR>
```

Insert the diskettes in the order they were made, according to the numbers you placed on their labels. Restoring will take approximately three minutes per diskette.

PROCEDURE B

If you are running XENIX Version 2.2a (or later) on the ACS 8600 and wish to install XENIX Version 2.2d (or later), or if you are updating any version of the ALTOS 586, you should use the following update procedure. It accomplishes the following tasks:

1. System files that you have probably changed (e.g., /etc/passwd, which gets changed when you run ua) are preserved.
2. User files are preserved.
3. Other system files are replaced by new files of the same name.

Overview of Procedure B

In brief, the procedure is to:

1. Log in as super-user (root) and shutdown the system.
2. Follow the regular installation procedure from Step 4; however, make.update should be run instead of make.hd, and update.hd should be run instead of load.hd.

CAUTION:

Do not run make.hd, or all of your existing files will be destroyed. Do not run load.hd or your system files will be overwritten.

Detailed Installation for Procedure B

1. Log in as super-user on the system console (port 1). This is done by entering the name "root."

```
login: root<CR>
```

If necessary, use the wall utility to ask other users to log off. To use the wall utility, enter:

```
# cd /etc <CR>
# wall <CR>
enter message <CR>
<Control-D>
```

The who utility informs you if any others remain. Do not proceed until you are the sole user. To use the who utility, enter:

```
# who <CR>
```

2. Bring the system down. Use the shutdown utility.

```
# /etc/shutdown<CR>
```

The shutdown utility asks

```
Minutes to shutdown? (0-15):
```

Enter the number of minutes you want to give other users to finish up and log off, for example

```
5<CR>

Broadcast Message ...

XENIX Shutdown in 5 minutes.
Clean up and log off.

XENIX Shutdown in 4 minutes.
Clean up and log off.

      :
      :
      :
XENIX Shutdown in 1 minute.
Clean up and log off.

XENIX will now terminate.
** Normal System Shutdown **
```

3. Press the **Reset** button, and prepare to press the **Space Bar** key as soon as you see this message:

```
PASSED POWER-UP TEST
ALTOS COMPUTER SYSTEMS - 586 (or ACS 8600)
Monitor Version n.nn

Press any key to interrupt boot
<Space Bar>
```

If you press the Space Bar key in time, you will see the display in Step 4. If not, try again.

4. When you see the following display, insert the diskette labeled "XENIX ROOT FILE SYSTEM" and enter 2 to "boot" from the floppy diskette.

NOTE

This diskette must be enabled for writing; that is, the computer system must be able to place information on it. If the diskette is write-protected, the system will give you a message. Consult the Diskette Handling chapter in the Operator's Guide.

586 Display:

```
Enter (1) to boot from Hard Disk
Enter (2) to boot from Floppy Disk
Enter (3) to enter from Monitor
```

```
Enter option: 2
```

8600 Display:

```
Enter (1) to boot from Hard Disk
Enter (2) to boot from Floppy Disk
Enter (3) to boot from Tape
Enter (4) to boot from Diagnostics
Enter (5) to enter Altos monitor
```

```
Enter option: 2
```

After a delay of 35-40 seconds, the following message appears.

```
586 (or ACS 8600) Xenix vn.na
```

```
mem = nnnK
#
```

The "#" is the XENIX prompt for the super-user. XENIX is ready for your commands.

5. Enter **fsck /dev/root<CR>**

This command causes the system to check to make sure that the file system on the floppy diskette is good before installing it.

```

# fsck /dev/root<CR>
/dev/root
** Phase 1 - Check Blocks and Sizes
** Phase 2 - Check Pathnames
** Phase 3 - Check Connectivity
** Phase 4 - Check Reference Counts
** Phase 5 - Check Free List
nn files nn blocks nnn free
#

```

6. If Step 5 is not successful, the "XENIX ROOT FILE SYSTEM" diskette is defective and must be replaced. Start over at Step 3 with a new diskette.

If Step 5 was successful, enter **make.update<CR>**.

This command installs the new XENIX kernel on the hard disk. It also installs the utilities necessary to update the system files and utilities.

```

# make.update<CR>
system update

```

Within a few minutes, you will see

```

After the system shuts down, boot from the
hard disk, then run update.hd

```

```

**Normal System Shutdown**

```

7. Remove the "Root File System" diskette to a safe place and proceed. We will now "boot" (start the system) from the hard disk.
8. Press the **Reset** button. Do not press any key when prompted. The system will read information from the hard disk, and, after a delay, give the XENIX display. This procedure "boots" (starts the system) from hard disk. Go to Step 10.

NOTE

If your ACS 8600 system is not equipped with EPROM Version 1.6, you should interrupt the automatic boot cycle by pressing the Space Bar when prompted (press any key to interrupt boot). If you are not sure which EPROM Version you have, press the Space Bar and go to Step 9.

```
PASSED POWER-UP TEST
ALTOS COMPUTER SYSTEMS - 586 (or ACS 8600)
Monitor Version n.nn

Press any key to interrupt boot
```

9. If you did happen to press a key, you will see the message below. If that happens, you can enter 1 to "boot" from the hard disk.

586 Display:

```
Enter (1) to boot from Hard Disk
Enter (2) to boot from Floppy Disk
Enter (3) to enter from Monitor

Enter option: 1
```

8600 Display:

```
Enter (1) to boot from Hard Disk
Enter (2) to boot from Floppy disk
Enter (3) to boot from Tape
Enter (4) to boot from Diagnostics
Enter (5) to enter Altos monitor

Enter option: 1
```

After a delay of about 15 seconds, the XENIX display appears.

```
586 (or ACS 8600) Xenix vn.na

mem = nnnk
#
```

10. When you see the XENIX prompt (#), enter **update.hd<CR>**.

```
# update.hd <CR>
Updating Xenix Utilities
-saving local system files
-copying in new utilities
```

11. At this point, the files to be preserved have been moved to a safe place. The procedure continues:

```
Please insert the diskette labeled Xenix
utilities #1 and press RETURN
```

12. Insert the diskette labeled "XENIX RUN-TIME SYSTEM UTILITIES #1 of n" and press the **Return** key.

As files are copied from diskette to hard disk, you will see messages of the form:

```
x "filename", nnnnn bytes, nn tape blocks
```

You will also see messages saying that a file has been linked to another file. These messages are for information only.

NOTE

Do not remove the diskette(s)---there are 2 for the ACS 8600---until prompted by the system to do so.

After the last file has been copied to hard disk from the diskette, the display of filenames will stop. You will see the message,

```
Remove diskette and store in a safe place.
```

13. Remove the XENIX Run-Time Utility diskette and store it. Meanwhile, the system is doing several minutes of internal processing. Do **NOT** do anything with the system until you see the prompt "#".

The screen should appear as follows

```
-restoring local system files
Update is finished
#
```

NOTE

Be sure this prompt has appeared before you continue with the next step.

14. If the previous steps were successful, your XENIX Run-Time System is correctly installed.

If you purchased the XENIX Development System, refer to the **Altos XENIX Development System Programmer's Reference Guide** for the additional steps required for installing the XENIX Development System.

If you purchased Altos communication network services, refer to the **Altos UNET User Guide** for information on how to install the communication network services.

If you purchased the ABS package or other software packages, refer to the **Altos XENIX Applications Software Guide** for information on how to install the ABS Menu Shell and the application programs.

If you wish to start XENIX up, see Chapter 8, Starting Up XENIX. If the system has not been shutdown, skip Steps 2 and 3 of the XENIX Starting Up Procedure.

If you don't plan on using your XENIX system at this time, you can shut the system down by entering:

```
# sync <CR>
# /etc/haltsys<CR>
** Normal System Shutdown **
```

RESUMING INTERRUPTED INSTALLATION

If you interrupt the installation procedure and are going to start over, try using **fsck /dev/hd0b** in order to clean up the disk. Then start again from Step 1.

For more information, refer to the description of the fsck program, which is described in the Checking and Cleaning Up Files section in Chapters 4 and 10.

Getting Started With Xenix 7

This chapter tells you how to get started with XENIX after the operating system is installed. It also tells you how to set up the Altos ports for your terminals and printers, and how to set up login user accounts for users of the XENIX operating system.

GETTING STARTED IN THE UNIX SHELL

After you have installed your XENIX operating system, you will see a pound sign (#) prompt on your screen. This is the super-user prompt in the standard UNIX Shell. You are in the single-user mode of operation. Exercise caution when working in the UNIX Shell as the super-user. You have more privileges than the regular user, but this means that you can have more of an effect (positive or adverse) on system performance.

Before bringing up the system for multi-users, you need to configure the ports for your terminals and printer. You should also create login user accounts for those who will use the XENIX system.

Bring up the system for multi-users by following the procedures in Chapter 8, Starting Up XENIX. The procedure brings up the system multi-user and logs you off.

AVAILABLE LOGIN NAMES AND SHELLS

Once the system has been brought up multi-user, the system displays "login" on each terminal. The system expects you to log in as an individual user or the system administrator. When you first start up, the Altos implementation of XENIX makes available "login names" to help you get started. However, you should create individual login user accounts for each user.

When you log on to the XENIX operating system, it may come up in any of four shells, depending on how the system has been configured and how the user logs in:

1. The ABS Menu Shell (optional)
2. The Business Shell Menu System
3. The UNIX Shell
4. The CShell (optional -- Development System only)

When you see the "login" message, you can reply with one of the following "built-in" login names:

admin -- When the ABS Menu Shell is not installed, logs you into the Business Shell Menu (Figure 3-1), as a super-user.

When the ABS Menu Shell is installed, logs you into the Master Control Services Menu (Figure 7-1), as a super-user.

The Master Control Services Menu allows you to access the Business Shell menu and the Altos Business Solution (ABS) menu. It also allows you to perform additional listed functions.

usern -- When the ABS Menu Shell is installed, logs you into the Altos Business Solution menu (Figure 7-2), as a regular user. ("n" is any number from 1 through 8.)

The Altos Business Solution menu allows you to access the available application programs.

User1 through **user8** are provided only when the ABS Menu Shell is installed.

How to use the ABS Menu Shell and its associated application programs is documented in the **Altos XENIX Application Software Guide**.

- root** -- Logs you into the UNIX Shell, as a super-user (# prompt).
- unix** -- Logs you into the UNIX Shell, as a regular user (\$ prompt).
- user** -- Logs you into the Business Shell menu (Figure 3-1), as a regular user.

How to use the UNIX Shell and the Business Shell is documented in Chapter 10, Using XENIX on a Regular Basis.

No password is required for these login names. However, you should assign passwords for **root**, **admin**, and **unix**. Before setting passwords for **admin** and **root**, be sure that you understand how to set them and what the ramifications are. Forgetting a password has disastrous consequences--neither you nor anyone else can get at any of the files--the whole system is lost! For more information on assigning passwords, refer to Chapter 9, Log In, Log Off, and Quit.

Using Login Names and Shells

If the ABS Menu Shell is installed and you only want to use the ABS or other application packages, log in as **usern**. For example:

```
login: usern <CR>
```

where: n = 1 - 8

brings up the Altos Business Solutions menu (Figure 7-2).

The information in the **Altos XENIX Applications Package User Guide** and the tutorial and help information provided with the menu systems offer assistance.

If you have not worked with UNIX or UNIX-like systems before and wish to access the XENIX utilities, log in as **user**. For example:

```
login: user <CR>
```

If you wish to explore the UNIX Shell, log in as **unix**. Later, you can move to the ABS Menu Shell or the Business Shell by logging in as **usern** or **user**. For example:

```
$ login user2 <CR>
```

Do not log in as **root** unless, or until, you have some knowledge and experience of XENIX or UNIX-like systems. The super-user privileges are meant to be used only for the good of the system and your fellow users. Actually, a minor mistake from the level of super-user could do a great deal of damage. Instead, log in as **admin**, which allows you to perform the super-user functions and gives you the built-in protections of the Business Shell and the ABS Menu Shell.

[Admin] ← (A)

User:admin ← (B)

(C) → Tue Jan 10 10:05 1983

MASTER CONTROL SERVICES

- a - The Altos Business Shell
- b - The Altos Business Solution
- c - The Altos Port configuration Utility

- d - Install Software Packages

- e - Disk Management
- s - Shutdown the System

- h - Help
- q - Quit (logout)

Please make your selection>

Notes: A denotes the name of this menu
 B denotes the name of the current user
 C denotes the date

Figure 7-1. Master Control Services Menu

[Start]
User: user

Wed Jan 12 10:06 1983

THE ALTOS BUSINESS SOLUTION

Applications

- a. Accountant
- b. Financial Planner
- w. Word Processor

- e. Electronic Mail
- b. Business Basic III

- k. Backup Important Files
- r. Restore Files

- h. Help
- q. Quit

Type a letter to make your selection>

Figure 7-2. The Altos Business Solution Menu

CONFIGURING THE PORTS

Before using the UNIX Shell, Business Shell, and the optional ABS Menu Shell, it may be necessary to tell the system what kinds of terminals are attached to each port. The Business Shell makes use of special terminal capabilities. The terminal screen may appear to you as "confused" because the Business Shell is attempting to use the capabilities of a different terminal setup.

The port configuration (pconfig) program is an interactive program used to configure terminals and printers for the system. It must be run by the system administrator.

You can access the pconfig program directly from the UNIX Shell (after becoming super-user) by entering:

```
# pconfig <CR>
```

Or, you can access it from the menu system:

Log in as **admin**.

If the ABS Shell is installed, the Master Control Services Menu (Figure 7-1) appears. Type **c**.

If the ABS Shell is not installed, the Business Shell Menu (Figure 3-1) appears. Type **k** to select the System Administration menu (Figure 3-4). Then, type **c**.

NOTE

When you use the pconfig program, you can be in the multi-user mode, but all other users should be logged off. This is because you must shut down the system and bring it back up again to configure the ports.

When you log in as **admin** and access the pconfig program via the menu system, the pconfig program invokes an automatic shutdown procedure.

If you make changes in the future, you may want to access the pconfig directly from the UNIX Shell as root. This allows you to make the port assignments changes without shutting down the system immediately. The next time you shut down the system, your changes are made.

When you first access the `pconfig` program, it displays its current terminal assignments for the six (on 586) or eight (on ACS 8600) serial ports. These ports are at the back of your Altos computer system and are identified with the numbers 1-6 (for 586) or 1-8 (for ACS 8600).

All ports are pre-configured and the code names display. Should you need to re-configure a port, supply a code name for the kind of terminal attached. Information is available to you under the HELP facility which lists terminal names and attributes. For additional information, refer to Appendix F, List of Terminal Capabilities. If a terminal you are using is not named, try picking the name of a similar terminal. If you need further assistance, contact your Altos dealer or Altos Customer Support group.

To configure your ports for the first time:

1. Type `c` and press the **RETURN** to change a port-device-speed-login assignment.

```
command? c <CR>
change which port? Type a port name.
```

3. Type **console** to configure your terminal (port 1 is the console).

The system displays the current speed (baud rate) for that port.

4. If that speed agrees with your terminal, press **RETURN**. If it does not agree, type the **correct baud rate** and press **RETURN**.

The system will display:

```
Currently you may login on port console.

Do you wish to be able to login on port
console in the future?

Type yes if you do; type no if not. Press
RETURN to leave things unchanged.
```

5. Press **RETURN**.

The port console is initially set for a "dumb" device. Specify a new device or press **RETURN** to leave the device unchanged.

6. Type **?** and press **RETURN** to scroll through the terminal options.

When you find your terminal type:

Press **any key** plus **RETURN** to stop scrolling.

Type the **device type** which corresponds to your terminal. For example, type **wyse** for the Wyse-100 terminal.

7. Repeat Steps 1 through 6 for each port (tty2 through tty6 (for 586) and through tty8 (for 8600)).

NOTE

The standard printer is assumed to be a serial printer operating at 9600 baud and connected to serial port 6 (for the 586) and port 8 (for the 8600). If you need to change the baud rate, or the port location, or support additional printers on your XENIX system, see Appendix D, Serial Line Printer and Spooler.

When you finish configuring the ports:

8. Type **q** and **RETURN** to quit. The system displays:

```
Are you certain the port assignments are now
correct? (y/n)
```

9. Type **y** and **RETURN** to confirm. The system displays:

```
PORT CONFIGURATION CONCLUDED
```

If you accessed the `pconfig` program directly from the UNIX Shell, as the super-user (root), the system displays:

The port assignment changes you specified have been made.
In order for them to take effect, you must shut the system.
When you bring the system back up, all ports will be configured.

To shut down the system, refer to the Shutting Down XENIX section in Chapter 10.

If you logged in as **admin** and accessed the pconfig program via the menu system, the system automatically goes through the shutdown procedures. The screen displays:

```
Minutes to Shutdown (0-15)
```

If you are the only user on the system, type **0** and **RETURN**.

If there are other users, first notify them of the time remaining, then type the desired number of minutes until shutdown.

At the end of the specified time, the system displays:

```
XENIX will now terminate  
** Normal System Shutdown **
```

To start up the system, refer to the procedures in Chapter 8, Starting Up XENIX.

CREATING AND CHANGING USER ACCOUNTS

The XENIX operating system has available login names when you purchase the system. See the Available Login Names and Shells section in this chapter. However, you should create user account login names for those who will use the XENIX system.

Adding users to the system or changing their characteristics is done with an interactive program named ua. To use the ua program, you must be logged in as super-user (root, admin, or via the su command).

You can run the ua program from the Business Shell. Enter **k** to access the System Administration menu, and then enter **a** to access the User Administration program.

You can run the ua program from the UNIX Shell by entering **ua** and pressing **RETURN**.

Figure 7-3 shows a typical screen display when using the ua program.

Creating a User Account

Once you have accessed the ua program, you can create a new user account by entering only the first letter of the commands: show, add, delete, change, user, Users, group, Groups, help, or !.

Enter **h** to obtain the help screen, which explains commands and command syntax. You can only enter one user or group at a time; do not use Users or Groups commands. (Note that **!** returns you to the UNIX Shell prompt.) If you want to add a user, enter **a--"add"** appears on the command line--enter **u--"user"** appears next to "add." After entering a name or group name, press the Return key.

If you make a mistake while typing, the Escape key backspaces over an entire user name or group name. <Control-x> cancels the current operation. Interrupt (RUBOUT or DEL) returns you to the command level.

For example, to add a user, enter the following on the command line:

```
add user desired name <CR>
```

The system responds with:

```
Updating new user: Desired name
```

The system then displays the default fields for the desired name. See Figure 7-3 for example.

You then see the prompt:

```
Which field?
```

Ensure that the password is not set (<NOT SET>).
Change the shell if desired.
Enter **q** to quit.

The system displays:

```
Installing files from /etc/newuser  
Command:
```

User Administration

Commands: show, add, delete, change, user, Users,
group, Groups, help, !, quit

```
a. User:      rich  
b. User ID:   28  
c. Group:     other  
d. Group Id:  1  
e. Password:  <NOT SET>  
f. Full Name: rich  
g. Directory: /usr/rich  
h. Shell:     /bin/bsh  
  
q. (quit -- return to top level)
```

```
Command: add user rich <CR>
```

Figure 7-3. Example of Creating a New User Account

Other Available Commands

Once you are in the `ua` program, you can add a new user account, display (show) a user account, delete a user account, change the fields of a user account (i.e., login shell), and create groups of users.

Guidelines

When you create or change a login user account, you should follow the following guidelines:

1. The user name cannot have a space in it. For convenience, a short name is recommended (i.e., rich). The user will be entering it often.

The name is to be entered exactly as created, including upper- and lower-case letters. For this reason, many people use only lower-case names. Such as, "mcgregor" instead of "McGregor."

2. If a name is created with only upper-case letters, XENIX assumes that the user has a terminal with only upper-case letters, such as a Teletype. Strange things happen, and the use of the system is hampered. When you are creating an account for someone, do not use a name with only upper-case letters unless that person actually has a terminal with only upper-case letters.
3. You (system administrator) should not set a password when creating an account. A password set when adding a new account is encrypted by the system, and neither the user nor the one who created it can access the account by entering that word again.

There are times when you want to "lock" an account. If you enter something in the password field, no one can use the account. You can do this as a Change function to an existing account. Enter only a carriage return as a change for the password field.

4. To unlock an account, or to remove a password that someone has forgotten, you simply change the password to nothing by entering a carriage return as a change for the password field.
5. When you assign a new user, the default shell (`/bin/bsh`) causes that new person to log into the business shell menu. If you want the user to be logged into a different shell, change it to one of the following:

- 1) /bin/bsh -- to log into the Business Shell menu (Figure 3-1).
- 2) /usr/bin/mini -- to log into the ABS menu (Figure 7-2) if the ABS Menu Shell is installed.
- 3) /bin/sh -- to log into the UNIX Shell (no menu).
- 4) /bin/csh -- to log into the "C" Shell if installed. (The C Shell is supplied with the XENIX Development System only).

Starting Up Xenix 8

BOOTING FROM HARD DISK

The following procedure explains how to start up your computer system for general use of XENIX by several people. Starting up the system is also called "booting" a system.

During single-user operation, an error made when entering information can be corrected by using the Backspace, Rubout, or Delete key.

1. Be sure that your terminal is connected to serial port 1 at the back of the Altos.
2. Turn on the Power Switch or, with the power on, press the **Reset** button.

NOTE

The ACS 8600 computer system is equipped with a Reset button on the front panel. The Altos 586 computer system may or may not be equipped with a Reset button on the front panel.

If your system does not have a Reset button, instead of pressing the Reset button, momentarily set the ON/OFF Power switch to OFF on the rear panel of your 586 computer system.

```
PASSED POWER-UP TEST
ALTOS COMPUTER SYSTEMS - 586 (or ACS 8600)
Monitor Version n.nn
```

```
Press any key to interrupt boot
```

If you don't press a key, the monitor will go to the hard disk and read in the XENIX system. This requires about 20 seconds or so. Go to step 3.

NOTE

On the ACS 8600 system with EPROM Version 1.5, press any key such as the Space Bar, to interrupt the automatic boot cycle; then proceed. If you are not sure which EPROM Version is in your system, press the Space Bar and proceed.

If you happen to press a key, within a few seconds you will see a choice of possible entries for "booting." If that happens, enter 1 to boot from the hard disk and go to step 3.

586 Display:

```
Enter (1) to boot from Hard Disk
Enter (2) to boot from Floppy Disk
Enter (3) to enter from Monitor
```

```
Enter option: 1
```

8600 Display:

```
Enter (1) to boot from Hard Disk
Enter (2) to boot from Floppy Disk
Enter (3) to boot from Tape
Enter (4) to boot from Diagnostics
Enter (5) to enter Altos monitor
```

```
Enter option: 1
```

3. The XENIX message should appear. If you see this, all is well. Proceed to the next step. *

```
Xenix vn.na
mem = nnnK
#
```

Sometimes you may get a different message. It starts "The system was not shut down properly..." If you see this message, see the following special procedure, "Recovering From Improper Shutdown."

4. XENIX is now running in "single-user" mode. Only the console you are using is active. Now we will bring it up for multiple users by entering **multiuser<CR>**.

```
# multiuser<CR>
```

The system asks you to enter the current date and time, and then comes up "multiuser." The system will log you off of port 1. The login prompt appears on all terminals.

5. Respond with your user name and password.

If you are starting up for the first time, enter **usern <CR>** (where n equals any number from 1 to 6), **user<CR>**, or **unix<CR>**. No password is required. "Usern" brings up the Altos Business Solution (if installed); "user" brings up the Business Shell; "unix" the UNIX shell. See Chapters 7 and 9 for more information.

An optional way of entering the time and date is by entering: **date yymmddhhmm<CR>**

where:

```
yy = current year
mm = current month
dd = current day of month
hh = hour (24 hour clock)
mm = minutes
```

After the next prompt, enter **<Control-D>** to bring XENIX up for multiple users.

RECOVERING FROM IMPROPER SHUTDOWN

1. You may see the following message because the system was not shut down properly when last used; for example, it may have been shut down by a power failure or a system crash. If you see it, ALWAYS enter **y**.

```
The system was not shut down properly, and
the root file system should be cleaned.
Proceed (y/n)? y
```

XENIX validates the consistency of the disk file system, which may have been damaged, and automatically repairs it. If all is well, you will see the following output:

```
/dev/root
** Phase 1 - Check Blocks and Sizes
** Phase 2 - Check Pathnames
** Phase 3 - Check Connectivity
** Phase 4 - Check Reference Counts
** Phase 5 - Check Free List
nn files nnn blocks nnn free

root structure was ok - proceeding with
bootup

#
```

If the file system was damaged, XENIX will repair it automatically, and display a log of the corrections. If you have any doubt whether the file system has been repaired satisfactorily, we recommend you restore the hard disk from recent saved files. (See the Saving and Restoring Files section in Chapter 10.)

For more information on file integrity checking, refer to the description of the `fsck` program, which is described in the Checking and Cleaning Up section in Chapters 4 and 10.

Log In, Log Off, And Quit 9

LOGGING IN AND PASSWORDS

To make use of the XENIX system, you need to log in, and to protect files you own, you need to have a password. The system may ask you to log in:

```
login: robert<CR>
```

Or, you may log in on your own in response to a system prompt:

```
$ login robert<CR>
```

SETTING AND CHANGING PASSWORDS

When you first log in with your user account login name, there will be no password assigned to your user account. You may set a password by following one of the following procedures. To maintain security, the password you type won't show on the screen.

From the UNIX Shell, enter:

```
$passwd <CR>
New password:  Type in any desired password <CR>
Retype new password:  Retype in same password <CR>
$
```

From the Business Shell menu (Figure 3-1), enter:

```
Type a letter to make your selection> b
```

NOTE

Selection b, Change Password, is located under the Basic Utilities category.

```
Changing password for (your login name)
New password:  Type in any desired password <CR>
Retype new password:  Retype in same password <CR>
```

```
[Type return to continue]
```

From the Business Shell or ABS Menu Shell, enter:

```
menu prompt > ! password <CR>
New password:  Type in any desired password <CR>
Retype new password:  Retype in same password <CR>
```

```
[Type return to continue]
```

NOTE

If you are changing your password, you will be prompted with "Old password:" before you are asked to type in the new password. Enter old password and press the Return key.

The next time you log in, you have to give the password.

```
$ login robert<CR>
password: <CR>
```

The password does not show.

If you forget your password, you cannot read your own files. The system administrator can remove your password (without knowing what it is), and you can enter a new one.

SETTING SYSTEM ADMINISTRATION PASSWORDS

As a matter of system security, it is important to set up passwords for the super-user functions, that is, to provide passwords for **root**, **admin**, and **unix**. Balancing the need of security is the basic need to run the system. Super-user status is required to set up new accounts, to shut the system down properly, and for many other basic functions.

Therefore, backup for performance of super-user functions is necessary. How this is done is a matter of management to be determined by the user. For example, several people might have the super-user password (perhaps a different password for **root** and for **admin**) and, in addition, written copies of the passwords might be stored securely with other crucial records.

LOGGING OFF OR QUITTING

To end your session, press **<Control-D>**.

```
$ <Control-D>
```

If you are in the Business Shell or ABS Menu Shell, choosing to Quit is the same as logging off.

A second login automatically logs off the prior one. If you log in under a different name, or someone else logs in on your terminal, your prior log in name is logged off.

For example, Alice has logged in (as **alice**) and is working on her files. A friend asks her to create an account for him. This requires super-user status, which can be gained by logging in as **admin**. Alice can either log off by pressing **<Control-D>** and log in as **admin**, or simply log in with

```
$ login admin<CR>
```

In either case, her login name of **alice** is logged off the system.

Using Xenix On A Regular Basis 10

USING THE BUSINESS SHELL MENU SYSTEM

Most of the XENIX system utilities can be accessed via the Business Shell Menu system. System utilities are programs that perform specialized services such as creating new accounts, shutting down the system, saving and restoring files, etc. The utilities described in this chapter can be accessed via the menu system. The menu system provides a simple entry into the XENIX system. To select a menu item, enter the letter of the service you want to perform. If that service has a submenu (e.g., Backup/Restore Files), a new menu appears. You now enter the letter of the desired service within that menu.

NOTE

Do not press the Return key when you make a selection and are in the standard Fast-Mode—type only the letter. If you press the Return key after typing your selection, you are returned to the previous menu. (To change to Slow-Mode, which requires you to press the Return key after typing the letter, refer to the Fast-Mode/Slow-Mode section under Chapter 3.

To return to the previous menu, press the Return key when any menu prompt is displayed.

Moving Between Shells

You can move from the Business Shell or ABS Menu Shell to the UNIX Shell in one of two ways. From the menu prompt line at the bottom of the menu screen:

- 1) Enter an **!** and press the **Return** key. The UNIX prompt displays, or
- 2) Enter **!**, the **XENIX command**, and press the **Return** key as shown:

```
! command <CR>
```

For example:

You are in the ABS Menu Shell and want to see how much disk space remains: the **df** command. You can either go through the sequence of menus or type in:

```
menu prompt > ! df <CR>
```

The system responds with the amount of disk space, for example **/dev/rroot 11174**, and the menu prompt:

```
[Type return to continue]
```

If you press the Return key, the system returns you to your last screen in the menu.

Entering the explanation point "connects" you directly to the UNIX Shell. If you type the explanation point without a command and press the Return key, you exit to the UNIX Shell. Within the UNIX Shell, you can enter UNIX commands supported by your system (refer to the **XENIX Development System Programmer's Reference Guide**).

To return to the BSH or ABS menu system, press **<Control-D>**. You are then prompted to press the Return key to return to the menu system.

For example:

```
menu prompt > ! <CR>

$ pwd <CR> (listed working directory)
/usr/rich

$ cd schedules <CR> (changes directories)
$ ls <CR>           (lists contents of directory)
planning          monthly          old.plan
weekly            budget
$ rm old.plan <CR>   (delete file)
$ <Control-D>
$ [Type return to continue] <CR>

The system returns you to where you were in the
menu system.
```

Accessing the Business Shell from the UNIX Shell

To move to the Business Shell Menu from the UNIX Shell, enter, after the prompt:

```
$ bsh <CR>
```

The Business Shell Menu appears on the screen awaiting your selection. If you type **q** at the Business Shell prompt line and press the **Return** key, you are back in the UNIX Shell at the **\$** prompt.

CONTROL CHARACTER SEQUENCES

Control character sequences provide the terminal functions described in the chart below. To form a control sequence, depress the Control key while pressing the designated alpha key.

CONTROL CHARACTER	FUNCTION
<Control-D>	Interrupts Process
<Control-H>	Backspaces and erases
<Control-Z>	Clears Screen
<Control-S>	Stops Display (Freezes)
<Control-Q>	Releases (Restarts) Display
<Control-U>	Kill Process
	Other special keys:
@	Kills a current line
Delete/Rubout	Kills the executing program

BASIC UTILITIES

The following basic utilities can be accessed via either the Business Shell or the UNIX Shell.

Changing Directory

To change to another directory via the Business Shell:

Select **a**, Change Directory. The prompt "Change to which directory?" displays on the prompt line. Enter the name of another existing directory. The system changes directories and places the current pathname above the data in the upper-righthand corner of the Business Shell Menu.

To change directories via the UNIX Shell:

Enter the Change Directory, **cd**, command followed by the name of another existing directory. (Use the List Directory, **ls**, command to verify existing directories.)

```
┌──────────────────────────────────────────────────────────────────────────────────┐
│$ cd Directory.3 <CR>                                                                                               │
└──────────────────────────────────────────────────────────────────────────────────┘
```

If the prompt returns, you are in the new directory. To display the directory's files, enter the list command, **ls**. If you are unsure as to when you are in the hierarchy, the Print Working Directory command, **pwd**, displays your current directory. By entering **cd** after the prompt, you are returned to your home directory: **/usr/xxxx**, where **xxxx** is your login user account name.

Creating A Directory

A directory can be set up to collect related files. The organization allows you to go directly to a set of files, similar to opening a file drawer devoted to one subject.

To create a directory via the Business Shell:

Select **d**, Create a Directory, from the main menu. Respond to the "Name of directory(s) to create?" prompt with the directory name and press the Return key. To verify that the directory was created, select the **c**, List Directory option. The directory should be listed, followed by a slash to distinguish it from a file, for example, **Newdirectory/**.

After you have created a directory, you can create new files within the directory. Enter **a**, Change Directory. You are prompted: "Change to which directory?" Enter the new directory name. The Basic Utilities now relate to the new directory. Note that the pathname in the upper-righthand corner (above the date) ends with the new directory. Now select **f**, Edit a file, to add a new file to the directory.

To create a directory via the UNIX shell:

Enter the `mkdir` command. For example,

```
$ mkdir Directory.1 <CR>
```

creates the new directory called `Directory.1`.

To create more than one directory, enter:

```
||| $ mkdir Directory.1 Directory.2 ... <CR>
```

If you name directories with initial caps, you can distinguish files from directories when you list the contents of your current directory. Remember that Directories contain both directories and files. Enter the List Contents of a Directory command, `ls`, to verify that the directory has been created. After you have created a directory, you can create new files within the directory.

Go to the directory via the Change Directory command, `cd`. Create files by entering the editor. After you write the file and quit the editor, the new file becomes a file under the new directory. You can also move existing files to your new directory by using the move command, `mv`, and specifying the new directory as the last part of the complete pathname, for example:

```
$ mv old.file /usr/group/Newdirectory/old.file <CR>
```

Listing Directory

To list the contents of a directory via the Business Shell:

Enter **c**, List Directory at the menu prompt line. Note that directories within directories are indicated by **/** after the name.

To list the contents of a directory via the UNIX Shell:

Enter the List Directory, **ls**, command followed by a carriage return. Refer to **A User Guide to the UNIX System** by Thomas and Yates, Chapter 4, for a description of the various **ls** options.

Removing A Directory

To remove a directory via the Business Shell:

Select **e**, Remove a Directory. You are prompted for the "Name of directory(s) to remove?" Enter the directory(s) and press the Return key. Note that you cannot be in the directory that you want to remove. Check your current pathname, which is displayed in the upper-righthand corner above the date. If necessary, change the directory by selecting the Change Directory menu item.

After removing a directory, select **c**, List Directory, to verify that it was removed.

CAUTION

When you remove a directory via the Business Shell, all of the directory files are also removed. If you want to save a file, copy it to another directory.

To remove a directory via the UNIX Shell:

Go to the directory via the Change Directory, **cd**, command, and list the files. The Remove Directory, **rmdir**, command will not remove a directory that contains files. You must remove the files one at a time via the Remove, **rm**, command. (Refer to the Removing a File section below.)

If, after listing the directory's contents, you decide to remove the directory and **all** of its files, use the Remove Directory and Files, **rm -rf**, command.

Editing A File

To edit a file via the Business Shell:

Select **f**, Edit a File (ed). You are prompted for the "Name of file(s) to invoke editor on?" Enter the file(s) and start your editing session. Refer to the Invoking the Ed Text Editor via the Menu System section of Chapter 11 for step-by-step instructions.

To edit a file via the UNIX Shell:

Enter ed and the filename at the UNIX prompt. Refer to the Invoking the Ed Text Editor via the UNIX Shell section of Chapter 11 for step-by-step instructions.

Removing A File

To remove a file via the Business Shell:

Select **g**, Remove a File. You are prompted for "Name(s) of file(s) to remove?" Enter the filename or multiple filenames separated by a space and press the Return key. List the directory to verify file removal.

If you enter a directory instead of a file, the word "directory" appears and nothing is deleted. Directories are shown by a "/" before the name as in /Letters.

To remove a file via the UNIX Shell:

Enter the Remove a File, rm, command followed by the filename(s) and press the Return key. For example, to remove the files memo.1 and memo.2, enter:

```
$ rm memo.1 memo.2 <CR>
```

Copying and/or Combining Files

To copy or combine files via the Business Shell:

Select **h**, Copy and/or Combine Files. You are prompted for the names of the "old file(s)" and the "new file." If you enter a single "old file," for example, june.1 and a single new file, for example, december.1, your directory now contains both files. Since they are identical in content, you have a back up file for security. Should you destroy part of a file, you can retrieve the original.

Note that the names of the old and new files must be different. If you copy two or more, the new file contains all of the old files attached one after the other. The old files still exist as independent files.

To copy files via the UNIX Shell:

Enter the Copy a File, `cp`, command followed by the filename(s) and press the Return key. For example, to create a backup file called `backup` of your memo file, enter:

```
$ cp memo backup <CR>
```

You now have two identical files.

To combine files via the UNIX Shell:

Enter the Concatenate, `cat`, command followed by the files to combine, and direct them into another file. For example, to combine file 1 and file 2 into file 3, enter:

```
||| $ cat file1 file2 > file3 <CR>
```

The "greater than" sign, `>`, means that files 1 and 2 are combined and redirected into file 3. Use the `cat` command (without the `>`) to display the new file on your screen. For example,

```
||| $ cat file3 <CR>
```

shows that file 2 has been appended to file 1.

Displaying A File

To display a file from the Business Shell:

Enter `i`, Display Files. You are prompted for "File(s) to display?" Enter one or more files separated by a space and press the Return key. The contents of the first file is displayed. After it is finished, a highlighted prompt "--More-(Next file: filename)" displays. Press Return to view the next file.

To display a file from the UNIX Shell:

Enter the **more** command and the filename, followed by the carriage return.

```
$ more filename <CR>
```

Each press of the Space Bar advances you twenty lines. Press the Return key to view the file line-by-line. At the end of the file, you are returned to the UNIX prompt (\$ or #).

Printing a File

To print files from the Business Shell:

Select **j**, Print Files. Respond to the "File(s) to print?" prompt with the name of the file(s) to be printed. (Your XENIX system must be configured to a connected printer.)

To print files from the UNIX Shell:

There are several utilities for printing material to a printer device. For example:

```
$ cat filename > /dev/lp <CR>

or

$ lpr filename <CR>
```

These utilities are discussed in detail in Appendix D, Serial Line Printer and Spooler.

SYSTEM ADMINISTRATION UTILITIES

SAVING AND RESTORING FILES

Altos recommends that you back up the file system on your hard disk regularly. The XENIX operating system has several utilities for copying files from hard disk to floppy disk and restoring them back to hard disk.

Of these programs, tar is especially useful and the easiest to use. The tar utility stands for "Tape Archive." It can be used with floppy diskettes, magnetic cartridge tape units, magnetic tape units (MTUs), or an add-on hard disk, if installed.

Using Tape Archive Utility (tar)

The tar utility permits the backing up and restoring of single files and whole directories or subdirectories. It is used in three major ways: to back up one or more files and/or directories; to restore one or more files and/or directories; and to obtain a list of current files on a particular diskette.

Using Tape Archive Utility from BSH Menu System

The easiest way to use the tar utility is to call it from the Business Shell Menu System. To backup/restore files via the Business Shell Main Menu (Figure 3-1):

- 1) Type **k** to access the System Administration Menu

NOTE

Do not press the Return key. If you press the Return key after typing your selection (k), you are returned to the main menu.

- 2) Type **b** to access the Backup/Restore Files Menu
- 3) The Backup/Restore Files Menu is displayed on your terminal, as shown below:

[Backup]
date

BACKUP AND RESTORE

user name-varies

- a. Backup File(s) and/or directory(s)
- b. Restore File(s)
- c. Restore the entire disk
- d. Display floppy disk directory
- e. Format a floppy disk

What backup/restore services do you desire?

- 4) Select the function you want to perform. For further explanation of these services, continue reading.

Formatting Diskettes

To save a file or a group of files, you need a sufficient number of floppy diskettes that have been formatted for double-density operation. Use the format utility. (The ADX diskette also has a format utility, but this cannot be run with XENIX in operation.)

As an aid in estimating the number of diskettes you will need, figure that each diskette can hold 1440 blocks (512 Characters per block) for 586 systems and 900 blocks for ACS 8600 systems. Files are saved across diskette boundaries, so all diskette space can be used. (Refer to Appendix B for information on floppy diskette organization.)

To access the format utility, perform one of the following:

From the Business Shell Menu:

- 1) Type **k** to access the System Administration Menu
- 2) Type **b** to access the Backup/Restore Files Menu
- 3) Type **e**, Format a floppy disk

From the UNIX Shell, enter:

```
$ Format <CR>
```

Whether you access the format utility from the Business or UNIX Shell, you are prompted to select one of the following options: standard single density, standard XENIX and diagnostic double density, or double-sided double density, if available. Select the number of your choice. The message "WORKING" displays while the diskette is being automatically formatted. After completion, the cursor returns to the prompt line. Exit from the program.

Saving Files

Insert a blank formatted diskette and enter the command:

```
||| | tar cv files <CR>
```

where:

c = c(create) option, which directs the tar utility to copy the specified files from the system hard disk to the backup medium (for example, floppy diskette).

v = v(verbose) option, which directs the tar utility to display a line on the terminal for each file backed up.

files = a list of any XENIX files, or directories, separated by spaces.

All files specified in the list are saved onto floppy diskette, including subdirectories and associated files of any directories you have specified.

For example, the command:

```
||| | tar cv /usr/john <CR>
```

may be used to save all files in the directory for /usr/john.

Similarly, the commands:

```
cd /usr <CR>
tar cv * <CR>
```

may be used to save all the files under /usr. "cd" changes the directory to /usr, and "*" means all files in the current directory. In this case, all files under /usr, such as /usr/john, /usr/alice, /usr/tom, and so on, will be saved.

You will be asked to remove and replace diskettes whenever another diskette is needed. Label and number the diskettes. (Be sure to indicate the total number, such as 1 of 5, 2 of 5, etc.) The sequence of diskettes is important because files are being saved across diskette boundaries. The first part of a file may be on one diskette, the rest on the next diskette. Files must be restored in the order they were written. When you are finished, store the diskettes in a safe place.

Restoring Files

To restore a directory, with all its subdirectories and files, proceed as follows. Insert the first floppy disk in the sequence, and change directory (`cd`) to the name of the directory to be restored. Enter

```
||| | tar xv <CR>
```

where:

x = x(extract) option, which directs the `tar` utility to copy every file from the floppy disk onto the system hard disk.

v = v(verbose) options, which directs the `tar` utility to display a line on the terminal for each file restored.

Optional filename = a single file or list of files and directories may be copied.

null file list (default) = If an option filename is not specified, every file from the floppy disk will be copied.

For example, to restore the files under /usr/john, check that there is a directory entry for /usr/john. Use the mkdir command to create one, if necessary.

Load the first diskette, and enter

```
cd /usr/john <CR>
```

Enter

```
tar xv <CR>
```

It is not necessary for the restore designation to match the designation used to save the files, so long as the file or files to be restored are among the saved files. In the example above, the /usr/john files could have been restored from files saved under, for example, /usr.

Typical Session

A typical file back-up session follows:

```
tar cv * <CR>
```

The two options are "c" and "v." The tar utility is told to back up all files and directories in the current working directory "*" onto floppy disk. The options "c" and "v" mean "create" and "verbose," respectively. The create option directs tar to copy the specified files from the system disk to the standard back-up medium, which is floppy diskette. The verbose option tells tar to display a line on the terminal for each file backed up.

One way to restore those files and directories is:

```
tar xv <CR>
```

In this example, the "x" option (for eXtract) and a null file list tells tar to copy every file from the floppy disk onto the system. The "v" (verbose) option operates as in the previous example; tar displays a line on the terminal for each file restored.

Listing Saved Files

The next example lists the files on a floppy diskette.

```
tar tv <CR>
```

The "t" option displays a line of information about each file on a floppy diskette. This line is similar to the information obtained by using the -l option with the `ls` (list) command. The name of the file, its permissions, owner name, date of last modification, and size in bytes are displayed.

Filenames and Directories

The form of file and directory names used in the `tar` utility is important. If a file or directory is specified with a complete path name (that is, a name beginning with /), such as

```
|| | /usr/john/tempest.c <CR>
```

`tar` records that a complete pathname was used and when this file is restored, it is put back as `/usr/john/tempest.c`, regardless of the working directory of the restorer. `Tar` overwrites any previous file of that name, and, if necessary, creates a directory in which to put it. Remember that a file name beginning with / is a complete pathname.

Using `tar` to Move Files

`Tar` can take a file or files from a specific directory and restore them in another directory. If, for example, there were a file named "tar.doc" in `/usr/john`, you can place it in `/usr/jim`. If the file had been specified without a path when created, it will be restored to the current working directory of the restorer. For example,

```
cd /usr/john <CR>
tar cv tar.doc alpha bravo charlie <CR>
```

saves the files `tar.doc`, `alpha`, `bravo`, and `charlie` from the current working directory of the creator, and

```
cd /usr/jim <CR>
tar xv tar.doc alpha bravo charlie <CR>
```

restores the same files into the working directory of the restorer. Note this would not work with a complete pathname, such as /usr/john/tar.doc.

Using tar with Tape Cartridge Option

The tar utility can back up and restore to a tape cartridge (if installed). The default device is the floppy diskette.

To save files, enter

For ACS 8600:

```
||| tar cvbf 8 /dev/ct0 /usr/john <CR>
```

For 586:

```
||| tar cvbf 8 /dev/rct /usr/john <CR>
```

which performs the same action as "tar cv *," except that the cartridge tape is used in place of the floppy disk and a single file (or directory) named /usr/john is placed on the tape. The "f" and "b" options are used to specify the I/O device and data blocksize: "/dev/ct0" for ACS 8600; "/dev/rct" for 586; and "8" are the cartridge tape device and tape blocksize. The "dev/rct" device, also known as the "raw" device, puts data on the tape with a blocksize that makes efficient use of the media. A blocksize of 8 corresponds to a 4K block. Acceptable blocksizes are 2K to 8K.

To restore files from cartridge tape, enter

For ACS 8600:

```
||| tar xvbf 8 /dev/ct0 /usr/john <CR>
```

For 586:

```
||| tar xvbf 8 /dev/rct /usr/john <CR>
```

Again, this invocation is similar to the example provided for floppy disk.

The ordering of options on the tar command line is important; tar responds "usage?" if they are not consistent. A good rule of thumb is to learn a particular ordering (such as those above). A skeleton tar command line looks like:

```
tar optionlist option1 ... optionN filelist <CR>
```

In the previous example, the "b" option is the first option in the options list, hence the specification for the "b" option should be the first thing following the options list. In a similar fashion, "f" is second in the option list and its corresponding specification is supplied after the specification for "b."

The form of file and directory names used in the tar command is important. If a file or directory is specified with a complete path name, such as

```
|| | /usr/john/tempest.c <CR>
```

Tar makes note that a complete pathname was used. When the file is restored, tar puts it back as /usr/john/tempest.c, regardless of the working directory of the restorer. Tar overwrites any previous file of that name, and, if necessary, creates a directory in which to put it. A complete pathname is one which begins with "/".

It is sometimes useful to be able to tar off a file or files from a specific directory and restore them in some other directory. If, for example, there was a file named "tar.doc" in /usr/john, one might like to be able to place it in /usr/jim. If the file is specified without a path when creating it, it will be restored to the current working directory of the restorer.

```
|| | tar cv alpha beta gamma <CR>
```

The above command will archive the files alpha, beta and gamma from the current working directory of the creator.

```
|| | tar xv alpha beta gamma <CR>
```

will restore those same files into the working directory of the restorer.

Tar provides for the archiving of files and directories which are too big for a single disk or tape to hold. Tar will prompt the user to insert another of whatever medium is being used. These should be numbered or otherwise marked for sequence since the order they are re-inserted when restored is significant.

If there is a problem with one of the sequence of disks of a multiple volume backup, the rest of the disks cannot be read back from tar. A solution for this problem is to require that each volume (disk or tape) hold only whole files. This also means that files which are larger than a volume cannot be archived in this fashion.

For ACS 8600:

```
|| | tar cvs 900 * <CR>
```

For 586:

```
|| | tar cvs 1440 <CR>
```

backs up all files/directories in the working directory and uses a size of 900 blocks for the ACS 8600 and 1440 blocks for the 586 per floppy disk volume. If this technique is used, the order of floppies for performing restore becomes unimportant. Similarly, if a single volume of a multi-volume tar is unreadable, the other volumes may be restored independently. The restore operation requires one invocation of tar for each volume backed up in this manner.

For ACS 8600:

```
|| | tar xvs 900 <CR>
```

For 586:

```
|| | tar xvs 1440 <CR>
```

restores any volume of a multiple volume backup. The cartridge tape uses a size option of 19500 (approximately 10 megabytes, allowing for a small percentage of unusable tape blocks).

Handling Diskettes

Remember that diskettes should be labeled with a description of the files saved and the date, and a sequence number if more than one diskette or tape is used.

For information on diskettes, see the Diskette Handling section in the **Altos Operator's Guide**.

RANDOM ACCESS DISKETTE FILES

When diskettes are used with the `tar` utility, they are treated as sequential files. Files on those diskettes are read from beginning to end, as with tape files.

It is also possible to have "Random-Access" files on diskette. XENIX can use random access diskette files in the same way it uses the hard disk files. You can have additional files that you load into the system when needed and unload when not.

Initializing Diskettes as Random-Access Files

To use a diskette in this fashion, you must first initialize it with an empty file system as follows:

1. If necessary, format the diskette using the `format` utility. After the XENIX prompt, enter `format <CR>`, and follow the instructions given.
2. Insert (load) the formatted diskette.
3. For 586 systems, enter

```
/etc/mkfs /dev/fd0 1440<CR>
```

For ACS 8600 systems, enter:

```
/etc/mkfs /dev/fd0.root <CR>
```

Although the newly created file system is physically loaded, you must "mount" the file system before you can use it. Mounting gives XENIX the information to link the diskette with its own file system on your hard disk.

Similarly, you must "dismount" (or unlink) the file system on the diskette before physically unloading that diskette.

Mounting a Device

Whenever a diskette file system is loaded, it must be mounted:

1. Insert (load) the diskette, if necessary.

2. For 586 systems, enter

```
/etc/mount /dev/fd0 /fd <CR>
```

For ACS 8600 systems, enter

```
/etc/mount /dev/fd0.root/maint <CR>
```

You may now access the diskette's file system through the directory /fd.

You can treat this directory as you would a directory on the hard disk. You can create files on it, transfer files to this directory, change or remove these files, etc.

Dismounting a Device

Before removing a mounted diskette, it must be dismounted:

For 586 systems, enter:

```
/etc/umount /dev/fd0<CR>
```

For ACS 8600 systems, enter:

```
/etc/umount /dev/fd0.root <CR>
```

2. Remove (unload) the diskette from the drive.

As with tar diskettes, these diskette files should be labeled with a meaningful description and dated, and kept in a safe location when not being used.

CHECKING AND CLEANING UP FILES

The `fsck` program, discussed under the Checking and Cleaning Up File Systems (`fsck`) section in Chapter 4, requires you to be a super-user to "clean up" files. You can check files as a regular user; however, no corrections are made.

Since you want to verify and repair any inconsistencies in the `/dev/root` file system, enter

```
# fsck /dev/root <CR>
```

To use the `fsck` utility on a system configured with a 40 megabyte hard disk, you must specify a file name of `/dev/rhd0.roc0`. For the 40 megabyte disk, enter

```
# fsck -t /dev/rhd0.roc0 /dev/root <CR>
```

As mentioned, `fsck` should be run by the System Administrator at least once a day. It should be run more often if problems become evident, such as the system not recognizing valid commands.

In the following example, the System Administrator ran `fsck` without any file errors appearing. The file system is in good order.

```
# fsck /dev/root <CR>

/dev/root
** Phase 1 - Check Blocks and Sizes
** Phase 2 - Check Pathnames
** Phase 3 - Check Connectivity
** Phase 4 - Check Reference Counts
** Phase 5 - Check Free List
2131 files  23863 blocks  7078 free
```

Below is an example of file system inconsistencies noted by running the `fsck` program. When you are prompted to CLEAR? or SALVAGE? after Phases 4 and 5, respectively, respond Yes. In fact, you should respond Yes to all prompted questions to enable the program to correct file problems.

```

# fsck /dev/root <CR>

** Phase 1 - Check Blocks and Sizes
** Phase 2 - Check Pathnames
** Phase 3 - Check Connectivity
** Phase 4 - Check Reference Counts
UNREF FILE I = 2124 OWNER=RICH MODE=100644
SIZE=30574 MTIME=Apr 27 07:56 1983
CLEAR?

** Phase 5 - Check Free List
63 BLK(S) MISSING
BAD FREE LIST
SALVAGE?

```

Command Syntax and Options

This section is from the Bell Laboratories' **UNIX Programmer's Manual**.

The `fsck` command syntax is

```
fsck [option] ... [filesystem] ...
```

where:

y = Assume a yes response to all questions

n = Assume a no response to all questions

sX = Ignore the actual free list and (unconditionally) construct a new one by rewriting the super-block of the file system. The file system should be unmounted while this is done, or extreme care should be taken that the system is quiescent and that it is rebooted immediately afterwards. This precaution is necessary so that the old, bad, in-core copy of the superblock will not continue to be used, or written on the file system.

The free list is created with optimal interleaving according to the specification X:

```
-sq:s space free blocks s blocks apart in
cylinders of c blocks each.
```

If X is not given, the values used when the filesystem was created are used. If these values were not specified, then `c = 400`, `s = 9` is assumed.

SX = Conditionally reconstruct the free list. This option is like **-sX** except that the free list is rebuilt only if there were no discrepancies discovered in the file system. It is useful for forcing free list reorganization on uncontaminated file systems. **-S** forces **-n**.

t = If **fsck** cannot obtain enough memory to keep its tables, it uses a scratch file. If the **-t** is specified, the file named in the next argument is used as the scratch file. Without the **-t** option, **fsck** prompts if it needs a scratch file. The file should not be on the file system being checked, and if it is not a special file or did not already exist, it is removed when **fsck** completes.

If no file systems are given to **fsck**, then a default list of file systems is read from the file **/etc/checklist**.

Inconsistencies checked are as follows:

1. Blocks claimed by more than one i-node or the free list.
2. Blocks claimed by an i-node or the free list outside the range of the file system.
3. Incorrect link counts.
4. Size checks:
 - Incorrect number of blocks in file.
 - Directory size not a multiple of 16 bytes.
5. Bad i-node format.
6. Blocks not accounted for anywhere.
7. Directory checks:
 - File pointing to unallocated i-node.
 - I-node number out of range.
8. Super Block checks:
 - More than 65536 i-nodes.
 - More blocks for i-nodes than there are in the file system.
9. Bad free block list format.
10. Total free block and/or free i-node count incorrect.

Orphaned files and directories (allocated but unreferenced) are, with the operator's concurrence, reconnected by placing them in the "lost+found" directory. The name assigned is the i-node number. The only restriction is that the directory "lost+found" must pre-exist in the root of the filesystem being checked and must have empty slots in which entries can be made. This is accomplished by making "lost+found", copying a number of files to the directory, and then removing them (before fsck is executed).

Checking the raw device is almost always faster.

SHUTTING DOWN XENIX

Before powering down your Altos computer system, use one of the following procedures to shut down XENIX gracefully. There is one procedure for the Business Shell, and two procedures for the UNIX shell, depending on whether or not other users are on the system.

During single-user operation, an error made when entering information can be corrected by using the Backspace, Rubout, or Delete key.

Business Shell Procedure

1. Log in as **admin** on the system console.
2. Select the "Shutdown" entry on the Master Control Services menu or on the System Administration menu. The system will ask:

```
┌───────────────────────────────────────────────────────────────────────────────────┐
│                                                                                   │
│                                                                                   │
│                                                                                   │
│ Minutes till shutdown (0 - 15):
```

3. Enter the desired number of minutes. The system will send a message to all users to finish and log off because the system will shut down in so many minutes (the number you specified).
4. The shutdown procedure terminates with the message:

```
|||  ** Normal System Shutdown **
```
5. If there is a floppy diskette in your system's drive, remove it.
6. Turn the power switch to OFF.

UNIX Shell: For Multiple Users

1. Log in as **root** on the system console. This establishes Super-User mode.
2. Enter **/etc/shutdown <CR>**. The system will ask:

```
# /etc/shutdown <CR>
Minutes till shutdown? (0-15):
```

3. Enter the desired number of minutes. The system will send a message to all users to finish and log off because the system will shut down in so many minutes (the number you specified).
4. The shutdown procedure terminates with the message:

```
||| ** Normal System Shutdown **
```
5. If there is a floppy diskette in your system's drive, remove it.
6. Turn the power switch to OFF.

UNIX Shell: For Single User

You can use the prior procedure, and enter 0 minutes, or this procedure.

1. Log in as **root** on the system console. This establishes super-user mode.
2. Enter the commands:

```
||| sync <CR>
    /etc/haltsys <CR>
```

3. XENIX responds:

```
||| ** Normal System Shutdown **
```

4. If there is a floppy diskette in your system's drive, remove it.
5. Turn the power switch to OFF.

MORE BASIC UTILITIES

All of the utilities discussed in this section are found under the System Administration menu, which is located in the System and Help section of the main menu.

Displaying or Setting the Date and Time

To display or set the date and time via the Business Shell:

Select System Administration, **k**, under the System and Help section of the main menu. Then, select **j**, Time and Date. You can either press the Return key to display the date and time, or enter the year, month, day, hour, and minutes in the following format to set the date and time:

YYMMDDHHMM

when: YY = current year
 MM = current month
 DD = current day of month
 HH = hour (24 hour clock)
 MM = minutes

For example, if you want to set the date and time to 2:30 p.m., December 31, 1983, enter:

```
8312311430 <CR>
```

To set the date and time via the UNIX Shell:

Log in as a super-user and enter:

```
|| | # date YYMMDDHHMM <CR>
```

Displaying Who is on the System

To display who is currently logged on the XENIX system via the Business Shell:

Select System Administration, **k**, under the System and Help section of the main menu. Then, select **k**, Who is on the System? The login names, terminal numbers, and date and time logged in appear as shown below:

root	console	Apr 28	13:34
jorge	tty 2	Apr 28	13:49
sandy	tty 3	Apr 28	13:57

To display who is on the system via the UNIX Shell:

Enter:

```
$ who <CR>
```

The current users are displayed as shown in the above example.

Displaying Processes

To display currently active processes via the Business Shell:

Select System Administration, **k**, under the System and Help section of the main menu. Then, select **l**, Display Processes to display all system processes in the long listing format.

The column headings that display are as follows:

<u>HEADING</u>	<u>MEANING</u>
F	Flags associated with the process: 01: in core 02: system process 04: locked in core (physical I/O) 10: being swapped 20: being traced by another process
S	State of the process O: nonexistent S: sleeping W: waiting R: running I: intermediate Z: terminated T: stopped
UID	The user ID of the process owner.
PID	The Process Identification (PID) number.
PPID	The ID number for the parent process.
CPU	Process utilization for scheduling.
PRI	Priority of the process; high numbers are low priority.
NICE	Number used in priority computation.

ADDR	If resident in memory, the core address. Otherwise, the disk address.
WCHAN	The event for which the process is waiting or sleeping. If blank, the process is running.
TTY	The tty controlling the process.
TIME	The cumulative execution time for the process.
CMD	Process

To display currently active processes via the UNIX Shell:

Enter the Process Status, `ps`, command with all three options (alx) for a display identical to that obtained through the Business Shell. For example,

```

$ ps alx <CR>

```

where:

- a = all processes associated with a terminal
- l = long listing format
- x = all processes not associated with a terminal

(See the column heading definitions above for a description of the display.)

Refer to the description of the `ps` command in **A User Guide to the UNIX System** by Thomas and Yates for more information.

Killing Processes

You may find it necessary to stop a process because you want to cancel it, or it is consuming too much of the system's resources. You must be a super-user to kill a process.

To kill a process via the Business Shell:

Select System Administration, `k`, under the System and Help section of the main menu. Select `l` to display system processes. Note the Process Identification (PID) number for the processes you want to kill. Then select `m`, Kill Processes. You are prompted, "Kill which processes?" Enter the process number(s) and

press the Return key. After you have killed a process via the Business Shell, the main menu returns to the screen.

If you receive the message, "No such process," the process may have completed. Verify by displaying the process.

To kill a process via the UNIX Shell:

Log in as a super-user. Enter

```
# ps alx <CR>
```

to determine the Process Identification (PID) number of the process to kill. Enter the **\$ kill** command, the PID number(s), and press the Return key to stop the process(es). For example, if you are running a BASIC program that loops, kill the program in order to exit from the loop.

Becoming Super-User

To have the privileges of a super-user, you need to know the super-user password, which is set by the System Administrator. Only super-users can kill processes, set the date and time, run the user administration program, change user group, configure ports, and shutdown the system.

To become a super-user via the Business Shell:

Select System Administration, **k**, under the System and Help section of the main menu. Then select **n**, Become Super-User. The message "Becoming super user ..." displays, and you are prompted for the Super-User password. You now have super-user privileges.

To become a super-user via the UNIX Shell:

Enter the super-user command:

```
$ su <CR>
```

Respond to the "password" prompt with the super-user password. You now have super-user privileges.

Listing Directory (Long Form)

To list your current directory in the long format via the Business Shell:

Select System Administration, **k**, under the System and Help section of the main menu. Then select **e**, List Directory (long) under Directories and Files. A listing of your current directory displays in the format shown below:

```
Directory: /usr/carol
total 4
drwxr-xr-x  2 carol 53  Apr 3  12:05  letter
drwxr-xr-x  1 carol 93  Apr 2  13:17  practice
```

where (for the first entry):

```
total          = total number of 512-byte blocks
drwxr-xr-x     = permission mode (refer to Changing
                File Permissions in this section.)
 2             = number of links to the letter file
carol          = file owner
53            = number of characters (bytes) in
                letter
Apr 3         = date of last change
12:05        = time (24-hour clock) of last change
letter       = file name
```

To list your current directory in the long format via the UNIX Shell:

Enter the List Directory command with the long listing option (-l):

```
$ ls -l <CR>
```

A listing of your current directory displays. (See the example, under "To list your current directory in the long format via the Business Shell" above.)

Changing File Permissions

An advantage of the XENIX file structure is that files can be shared by members of your group and other system users unless you change the permission mode. When a file is created, it can be read by all users. (Directories can be read and executed by all users.) There are three levels of permission--read, write, and

execute--for three kinds of users--you, your group, and other system users. You have read, write, and, if appropriate, execution permission for your files. Some files, such as a letter file, are not executable.

To check your file permissions, List Directory (long) under System Administration Utilities. A line is displayed for each file. Note the positioning of r, w, x. An "r-x" means that write permission is denied.

```
  -rwx  rwx  rwx  1  carol  9  Apr 27  15:13  memo
      |   |   |
      user group other
      (you)
```

where: - (first entry) = file; d = directory

r = read
w = write
x = execute

- (after first entry) = permission denied, whether read, write, or execute depends on placement.

To change file permission via the Business Shell:

Select System Administration, **k**, under the System and Help section of the main menu. Then select, **f**, Change File Permissions. You are prompted for the "File(s) for which permissions are to be changed?" Enter the file(s). You are then shown the current permissions and prompted: "Change files to permission."

First, enter the class(es) of users for which permission is to be changed. This is some combination of "u" (user), "g" (group), or "o" (other) (or all three; "a" is the default). You can add (+) or remove (-) one of the three permissions: "r" (read), "w" (write), or "x" (execute). For exaple, if you want group members to execute one of your files, enter

```
$ g+x filename <CR>
```

If you want to deny group members and others read permission for a file, enter

```
$ go-r filename <CR>
```

To change file permission via the UNIX Shell:

Enter the Change Mode, chmod, command, followed by the class of users, the "+" for adding, or "-" for removing access, and the read, write, or execute permission. Refer to the above discussion via the Business Shell. For example, to give your group members write privileges for a file, enter

```
$ chmod g+w filename <CR>
```

Changing File Ownership

To change file ownership via the Business Shell:

Select System Administration, **k**, under the System and Help section of the main menu. Then, select **g**, Change File Ownership. You are prompted for "File(s) for which ownership is to be changed?" Enter the file(s). You are shown the current owner(s) for the file(s), and prompted "Change file to owner." Enter a valid owner name. When you list your directory, the file(s) are displayed in your directory with their new owner name.

To change file ownership via the UNIX Shell:

Enter the Change Owner, chown, command, followed by the new owner name, and the filename. For example, to change the owner of the file "memo" from carol to george, enter

```
|| / $ chown george memo <CR>
```

When carol's current directory is listed, george is shown as the owner of "memo."

Changing File Groups

To change file groups via the Business Shell:

Log in as a super-user.

Select System Administration, **k**, under the System and Help section of the main menu. Then, select **h**, Change File Group. You are prompted for the "file(s) for which the group is to be changed?" After you enter the file(s), the "current group(s) for these files" is displayed. You are prompted "Change files to group:" Enter a valid group name.

To change file groups via the UNIX Shell:

Log in as a super-user. Enter the Change Group, chgrp, command, followed by the new group name, and the filename. For example, to change the group of the file named "memo" from /other to /dev, enter

```
# chgrp dev memo <CR>
```

Displaying Disk Usage (File Space)

Monitoring disk usage is important because you will want to free disk space by deleting old files that are taking up valuable file space.

To display disk usage via the Business Shell:

Select System Administration, k, under the Directories and Files section of the main menu. Then select, i, File Space. First, the remaining disk space (free blocks) is shown. Then, directories and their block size, in 512-byte blocks, are listed in this format:

```
8 ./directory1
12 ./directory2
22 .
```

where "." is your current directory, "22" is the sum of the blocks in your current directory. To determine individual file sizes, display disk usage via the UNIX Shell.

To display disk usage via the UNIX Shell:

Enter the Disk Free, df, command to display the number of free blocks of disk space available. For example,

```
$ df <CR>
```

Enter the Disk Usage, du, command to display the number of blocks contained in your directories. For example,

```
$ du <CR>
```

By entering the df and du commands, you will get the same display as selecting File Space under the Business Shell Menu System.

You can specify a specific directory name (\$ du directory-name) instead of the current directory (.), the default directory.

You can request the sum of blocks for all of your files: \$ **du -s** <CR>, or display an entry for each file by using the \$ **du -a** <CR> command.

For more information, refer to **A User Guide to the UNIX System** by Thomas and Yates.

USING ELECTRONIC MAIL FACILITY

XENIX provides system users with a convenient means of communicating messages via the terminal--electronic mail. As with the postal service, you can send or receive mail. After receiving mail, you can save it in various places (files) or discard it.

Sending and Receiving Mail via the Business Shell:

Select **1**, Electronic Mail, under the System and Help section of the main menu. You are prompted whether you want to receive mail or send mail.

To send mail, select **b**. You are asked to enter the login id of the person to whom you are writing. Then type the message. When finished, terminate the message by entering a <Control-D>. Press the Return key to return to the previous menu.

To receive mail, select **a**. Any mail in your file is displayed, one after the other, starting with the most recent mail. After a message displays, a **?** prompt appears on the command line. If you press Return, the next message displays. If there are no more messages, pressing the Return key returns you to the previous menu.

When the ? prompt displays, you have various options:

Options	Results
d <CR>	Deletes last message, next message displays
m user <CR>	Mails message to specified user login id.
p <CR>	Displays previous message again
q <CR>	Quits, returns to prompt line
s [file] <CR>	Saves message in your current directory's mbox file, or the file you specify
w [file] <CR>	Writes the message (without heading) to your current directory's mbox file, or the file you specify
x <CR>	Exits to the prompt line without changing the message

Refer to **A Use Guide to the UNIX System** by Thomas and Yates for additional information on the **mail** command.

Sending and Receiving Mail via the UNIX Shell:

To send mail, enter the Mail, **mail**, command at the prompt, followed by the recipient's login id. For example,

```
$ mail zeno <CR>
```

Type the message on the screen. Terminate with a <Control-D>. The next time zeno logs on, "You have mail" displays.

To receive mail, enter

```
$ mail <CR>
```

You have the options listed above under Sending and Receiving Mail via the UNIX Shell.

RUNNING A PROGRAM

To run a program, select **m**, Run a Program, under the System and Help section of the Business Shell Main Menu. You may execute a program in either the a.out or arbitrary file. Select **a** to execute the program in the a.out file. The a.out file usually contains the result of the last compilation. Enter **! program**, where program equals the program name to run an arbitrary file. For example, if your system has the **learn** program, enter

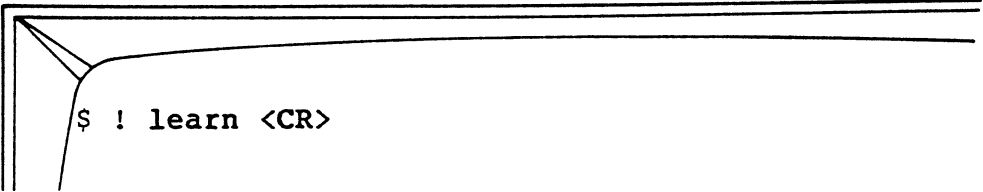

```
$ ! learn <CR>
```

USING NETWORK SERVICES FACILITIES (OPTIONAL)

Network Services enable you to access other system resources from your terminal. You can log in to another system and copy a file, or receive one from another system. You can display other system directories, or print files on another system's printer.

The two available Network Services are ALTOS-NET and ETHERNET. ALTOS-NET, available on the Altos 586 and 68000 systems, supports a maximum of 32 systems. ETHERNET, available on the 586, 68000, and 8600 systems, supports a maximum of 100 systems.

Refer to **Using UNET Local Area Networks with ALTOS-NET and ETHERNET** for complete Network Services documentation.

OBTAINING HELP WHILE IN BUSINESS SHELL

Select **r**, **Help**, under the System and Help section of the main menu. There are help menus for each system menu. You have the option of selecting:

- a. Help on the Business Shell commands, or
- b. List of menus in the system

If you select **a**, a list of the Business Shell commands displays. Enter the letter associated with the command; for example, **f**, for a description of **!command**. A short explanation is given.

If you select **b**, you receive a list of system menus. To go directly to a menu, enter the menu name; for example, **Backup**. To display the help screen for that menu, enter **Backup?**

LIST OF USEFUL COMMANDS AND UTILITIES

Table 10-1 lists useful XENIX Run-Time System commands and utilities.

Table 10-1. List of Useful Commands and Utilities

<u>COMMAND/ UTILITY</u>	<u>DESCRIPTION</u>
bsh	Business Shell. A menu-driven user system with special guidance and convenience features. Enables you to access the more commonly-used UNIX utilities via menus.
cat	Displays a file.
cd	Changes directory. Changes your current position in the File System hierarchy.
chgrp	Change file group identification.
chmod	Change mode. Changes file protection attributes.
chown	Change file ownership.
cp	Copy a file.
date	Display and set the date.
dd	Convert and copy a file.
df	List free blocks. Displays the number of free blocks on the file systems.
du	Summarizes Disk Usage. Displays the number of blocks contained in all files and directories.
echo	Echos arguments.
ed	The standard UNIX text editor.
fcopy	Copy a floppy diskette, while in XENIX.
find	Find files. Searches each directory in pathname listed to find files that meet the specified conditions.
format	Format a floppy diskette while in XENIX.

Table 10-1. List of Useful Commands and Utilities (Continued)

<u>COMMAND/ UTILITY</u>	<u>DESCRIPTION</u>
fsck	File system consistency check and interactive repair.
kill	Terminate a process.
layout	Configure a hard disk.
ln	Make a link.
login	Sign on.
lpr	Line printer spooler.
ls	List. Displays the contents of the current directory.
Mail	Send and receive mail. (The University of California, Berkeley "Mail" utility goes in front of, and makes use of, the Bell Labs "mail" utility. The names of the two utilities are distinguished by whether the first letter is capitalized or lower case.)
map	Create an alternate sector map for a hard disk drive.
mkdir	Make a new directory.
mknod	Build special files.
mount	Mount a file system.
multiuser	Bring the system up multiuser.
mv	Move. Renames files and directories.
passwd	Change login password.
ps	Process status. Displays system status.
pwd	Display working directory. Displays current position in the directory hierarchy.
reset	Reset the terminal status bits to a predefined state.
rm	Remove. Deletes a file.

Table 10-1. List of Useful Commands and Utilities (Continued)

<u>COMMAND/ UTILITY</u>	<u>DESCRIPTION</u>
rmdir	Delete a directory.
sh	A command programming language.
sizefs	Determine the size of a logical device from the layout information associated with a hard disk.
sleep	Suspends execution for an interval of commands and utilities.
stty	Set terminal options, such as baud rate.
su	Switch user. Substitute user id temporarily and allows you to be super-user or other user on the system.
sync	Updates the super block.
tar	File system archiver. May be used for file system dumps and restores.
termcap	Data base which defines cursor-control sequences for most commonly used CRTs. It is used by most "screen oriented" software, such as the Altos shell and visual screen editor, <u>vi</u> .
tty	Displays your terminal number.
ttytype	Data base for defining terminal type associated with each serial port.
ua	User administration. Adds and deletes user accounts on the system.
umount	Unmount a file system.
wall	Write to all users.
who	Displays who is on the system.
who am i	Displays how you are logged in.

NOTE

For additional information, refer to Appendix G, Sample Listing of XENIX Run-Time Utilities, Chapter 10, and A User Guide to the UNIX System by Thomas and Yates.

Using The Ed Text Editor 11

INTRODUCTION

Ed, the standard UNIX text editor, provides an interactive program for creating, viewing, and modifying files. Ed is a line-oriented text editor. It allows you to enter a single command or manipulate text on a line-by-line basis. A line consists of a single command or of text entered until the Return key <CR> is pressed. Once you are in the proper operating mode, you can enter text as you would on an electric typewriter.

The ed editor does not have the sophistication of a screen-oriented text editor or a word processor.

A screen-oriented text editor allows you to move the cursor around in a file. Changes and additions that you make to the file are reflected in what you see on your terminal screen.

A word processor is a program that includes both a screen-oriented editor (for typing text) and a program that runs the printer (for printing text); this program allows you to backspace, underline, justify margins, expand tabs, and type in boldface type.

Ed is adequate for creating simple text files (i.e., creating files for the electronic mail program), or doing system maintenance functions (such as modifying the ttys file as explained in Appendix D).

If you purchased a word processor with your system, use it instead of the ed text editor for creating and editing your text files, such as letters, memos, and documents.

If you purchased the XENIX Development System, use the vi screen-oriented text editor instead of the ed text editor.

This chapter will give you enough information about the ed text editor for most of your day-to-day needs. Refer to **A User Guide to the UNIX System** by Thomas and Yates for a more comprehensive discussion of ed.

ED BASIC CONCEPTS

Before using ed, you should be familiar with some basic concepts.

Files and Directories

A file is a collection of information, either text or data. Each file is assigned a name. Files are normally grouped under directories. Similiar files are normally grouped under the same directory. When using ed, be sure that you are in the correct directory; either for creating a file or editing an existing file. Otherwise you will get an error message (?). Refer to Chapters 1 and 2 for more information about file and directory concepts.

Text

The term "text" in this tutorial refers to the standard definitions such as memos, or documents. Text can also consist of data being entered, such as data for a program.

Buffer and Disk Space

A buffer is a block of memory inside the computer reserved for text editing. Text being worked on is kept in the buffer. The buffer serves as a temporary work space. You need to copy (write) your file from the buffer to the hard (or floppy) disk to save it. Otherwise, when you exit the editor your file will be lost.

Commands, Command Mode, and Input Mode

There are two modes: the command mode and the input mode. The first allows you to give the editor directions and the second allows you to enter and manipulate text or data.

You instruct the ed text editor what to do with your file by entering commands while in the command mode. Most commands consist of a single lower-case letter, such as "a" for adding text, or "m" for moving text. Each command is entered on a separate line. You can enter commands as soon as you invoke the ed editor.

The input mode is entered from the command mode by entering the appropriate commands, which are described below. Once you are in the input mode, you can add text to the ed editor buffer area in the computer.

There is no prompt in either mode. You should know which mode you are in. If you not sure, type a period as the first character on the line, then press the Return key. If you were in the input mode, you are now in the command mode. If you were in the command mode, the editor responds with a question mark if there are no lines in the buffer, or will display the contents of the current line in the file. Any time you get a question mark response from the editor, you know you are in the command mode. See the Error Messages section below for more information on the question mark.

Error Messages

When you are in the command mode, the system displays a question mark whenever you make an error while entering commands, or when you press the Return key without entering a command first. You will also get a question mark response when you invoke ed with a filename that is not present in the current directory. If you are creating a new filename, ignore the question mark. If you are requesting an existing file, be sure you are in the proper directory and that the file you are requesting exists in that directory.

INVOKING THE ED TEXT EDITOR

With the Altos implementation of XENIX, you can invoke the ed text editor in several ways: from the menu system there are two ways and from the UNIX shell there is another way.

Via the Menu System

To invoke the ed text editor while working within the menu system:

1. Select **a** from the Master Control Services Menu (Figure 2-1).

The system displays the Business Shell Menu (Figure 3-1) on your terminal screen.

2. Select **f** under the Basic Utilities Menu Listing.

The system enters the ed text editor and prompts you with:

```

Name of file to invoke editor on ?

Enter the name of the file you want to view,
create, or modify.
```

If you selected an existing file, the editor responds with the number of bytes in that file. One byte holds one character (letter, number, space, punctuation mark, or special symbol). The editor is now in the command mode awaiting further instructions from you.

|| |

If you selected a new file name, the editor responds with:

```

?filename
```

The system searches for the file and responds with a question mark. It then creates this file when you save the file.

The system responds with a question mark indicating that the file is not present. This is the editor's way of letting you know it is a new file. The editor is now in the command mode awaiting further instructions from you.

Another way to invoke the ed text editor while in the menu system is to enter the following after any menu system prompt:

```
Prompt> !ed filename <CR>
```

After you exit the file being worked on, press the return key when prompted by the system. This action returns you to where you were in the menu system prior to exiting to the UNIX shell.

Via the UNIX Shell

To invoke the editor while working in the UNIX shell, enter:

```
# or $ ed filename <CR>
```

If the file is not present, the system responds with:

```
?filename
```

The system searches for the file and responds with a question mark. It then creates this file when you save the file.

If the file is present, the system responds with the number of bytes in the file.

Either way, the editor immediately enters the command mode awaiting further instructions from you.

CREATING A NEW FILE

You create a new file by invoking the ed text editor with a new filename.

BASIC ED COMMANDS

Here are some of the basic `ed` commands discussed in this chapter.

COMMAND	FUNCTION
a	Adds text to a file
.	Exits from add or append command mode
p	Prints or lists a file
s	Substitutes or makes changes within a line
u	Undoes the last command
d	Deletes words within a line
m	Moves text lines around in a file
r	Reads or appends existing files to the current file
w	Writes or copies (saves) current file to disk
q	Quits or exits the editor

ADDING TEXT (LINES) TO A FILE (a)

To add text to a new or existing file, use the **a** command. This command enables you to enter text on the "blank" lines that follow. Each time you press the Return key, a new line becomes available. When you are adding text to a newly created file, type in **a** followed by pressing the **Return** key. For example:

```
$ ed example <CR>
?example
a <CR>
This is the text portion of a newly          <CR>
created file, named example. Once I         <CR>
have finished adding lines of text, I      <CR>
will exit the input mode by entering a     <CR>
period followed by pressing the Return    <CR>
key.
. <CR>
```

You can enter the input mode from the command mode, in the following ways:

```
Type a <CR> to add text after the current line in
the file.
Type Na <CR> to add text after line N in the file.
Type i <CR> to add text before the current line in
the file.
Type Ni <CR> to add text before line N in the
file.
```

Exit the input mode by entering:

```
. <CR>
```

You can enter a specific line number before entering the **a** command to start adding lines after the specified line number. For example, by entering **25a**, you will be adding lines starting with line 26.

DISPLAYING (LISTING OR PRINTING A FILE) (p)

To display or list the contents of the buffer on your terminal, use the print, **p**, command. You can display part or all of the file by entering one of the following:

1. By entering **l,\$p**, the entire buffer (file) will be displayed on your terminal.
2. By entering **Np**, line N will be displayed on your terminal.
3. By entering **N,Zp**, lines N through Z will be displayed on your terminal.

For example, to display the contents of the "example" file created under the Adding Text section, enter:

```
l,$p <CR>
```

```
This is the text portion of a newly  
created file, named example. Once I  
have finished adding lines of text, I  
will exit the input mode by entering a  
period followed by pressing the Return  
key.
```

NOTE: The "a" and "." entered when adding this text portion are not part of the buffer.

The example below displays lines 4 and 5 of the example file:

```
4,5p <CR>
```

```
will exit the input mode by entering a  
period followed by pressing the Return
```

MAKING CHANGES WITHIN A LINE (s)

You can make changes within a line by using the substitute, s, command. This command is useful for correcting typos, adding or deleting words, or substituting words with a line. The format for using the s command is as follows:

```
line#s/old text/new text/p <CR>
```

where:

Line# = the line you want to change. If you do not enter a line number, the editor make the substitution to the current line.

s = the substitute command

old text = what you want to change

new text = what you want to change to

p = prints the line after the changes are made

The following are examples of the substitute command:

Example 1

You want to correct the typo (budgt) in the following line with your file.

```
Your budgt figures are higher than projected.
s/budgt/budget/p <CR>
Your budget figures are higher than projected.
```

The editor replaces the word "budgt" with the word "budget."

Example 2

You want to delete a word(s) in the following line.

```
Please submit your vacation schedules to me today.
s/to me//p <CR>
Please submit your vacation schedules today.
```

The words "to me" were deleted from the line.

Example 3

You want to change a word or word set throughout a large file. This is a global change.

```
s/manual/document/gp <CR>  
This document describes the 586 computer system.  
Refer to the reference document for more information.  
This document will be revised as needed.
```

This command substitutes the word "document" for the word "manual" throughout the file and then prints each line that was changed. The "g" that was added to the command line indicates that it is a global substitution.

Example 4

You can add text within the line by using the s command.

```
Please return the keys you borrowed.  
s/keys/keys and book/p <CR>  
Please return the keys and book you borrowed.
```

As you can see the s command is an important editing tool. Another feature of the substitute command, is reversing the last substitution you made by using the undo, u, command. The undo command only reverses the most recent substitution and only works if the editor is currently positioned on the affected line. To use the undo command, enter

```
u <CR>
```

DELETING TEXT (LINES) (d)

If you want to delete words within a line use the s command. If you want to delete lines of text, use the delete, d, command. To delete lines, type:

(first line to delete), (last line to delete) d

For example, if you want to delete line 4 of the file in the buffer, type:

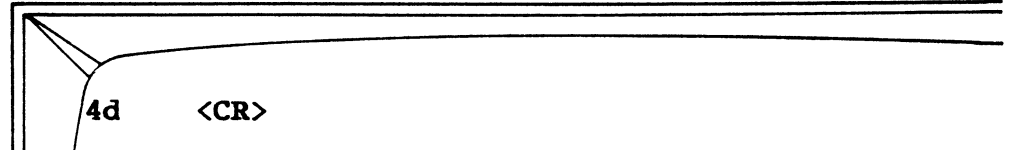

A diagram of a buffer window, represented by a rectangle with a double-line border. Inside the window, the text '4d <CR>' is displayed. The text is positioned in the upper-left corner of the window, with a small triangular shape pointing towards the top-left corner, indicating the cursor's position.

An example of deleting more than one line is as follows. To delete lines 4 through 7 of the file in the buffer, type:

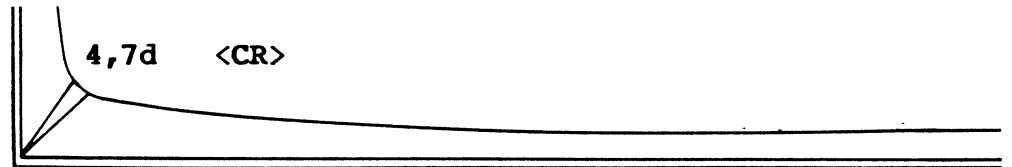

A diagram of a buffer window, represented by a rectangle with a double-line border. Inside the window, the text '4,7d <CR>' is displayed. The text is positioned in the upper-left corner of the window, with a small triangular shape pointing towards the top-left corner, indicating the cursor's position.

NOTE: The delete command does not prompt you nor does it display the buffer. To display the file before or after deleting text, use the print, p, command.

MOVING TEXT (LINES) AROUND IN A FILE (m)

To move lines of text around within the buffer without having to retype them, use the move, **m**, command. For example, if you wanted to move lines 3 through 6 to the end of the buffer, type:

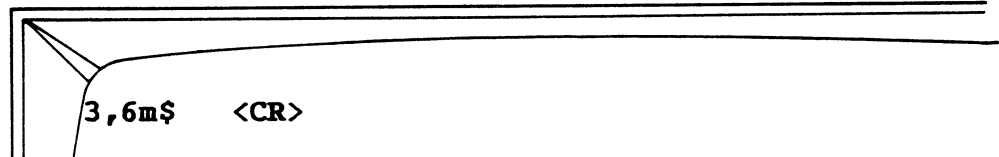

A diagram of a buffer window with a double-line border. Inside, the text `3,6m$ <CR>` is shown. A vertical line is drawn at the start of the text, and a horizontal line is drawn at the end of the text, meeting at a point that indicates the cursor's position.

NOTE: The dollar sign (\$) is used to indicate the end of the buffer (last line).

Another example is:

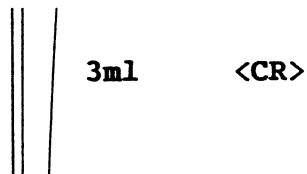

A diagram of a buffer window with a double-line border. Inside, the text `3m1 <CR>` is shown. A vertical line is drawn at the start of the text, and a horizontal line is drawn at the end of the text, meeting at a point that indicates the cursor's position.

This example moves line 3 after line 1.

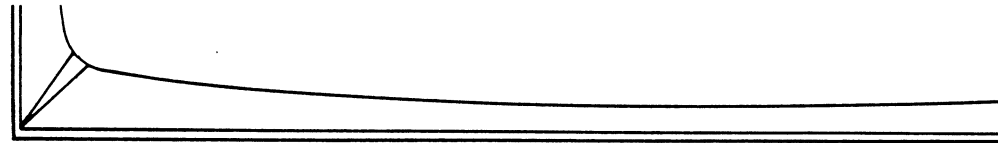

A diagram of a buffer window with a double-line border. The text is blank, representing the state after the command has been executed.

COMBINING FILES (r)

You can combine more than one file in the ed text editor buffer by using the r command. This command allows you to "read" a file into the buffer without destroying anything that is already there. For example, you have a named report, which contains a report of your expenses. You can edit a file or create a new file in the buffer and then combine it with an existing file (in this case report). To do this example, type:

```
r report <CR>
```

This command causes the report file to be copied into the buffer after the text already in the buffer. You can rename the combined files by using the w command to write to the disk as shown below:

```
w newfilename <CR>
```

SAVING YOUR TEXT/FILE (COPYING FILE TO DISK) (w)

When you are making additions or modifications to a new or existing file, you are working in a temporary storage area in the computer system called a buffer. To save (write) your files, you need to make a copy of the buffer contents and put it on the hard or floppy disk.

Writing out the contents of the buffer into a file and copying the file to disk is accomplished by using the write, w, command.

To save the additions or modifications you made to your file, exit the input mode and type in w. The system responds with the number of bytes in the file. For example,

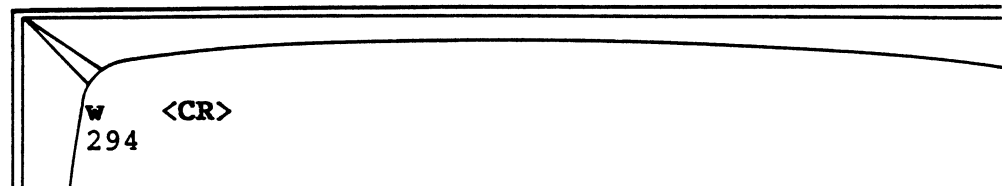

```
w <CR>
294
```

You now have a "saved" copy of your file with the latest changes. The text in the buffer remains unchanged. You can continue adding or modifying the buffer without affecting the saved file unless you "write" to the disk again.

You should save (write) the text in the buffer before you exit the editor. You should also "write" to the disk periodically while working on text in the editor buffer. This is important for the following reasons:

1. If there were a power surge, power outage, or if someone accidentally reset the system, your text in the buffer would be lost. If you saved (wrote) you file periodically (i.e., once a page), you can easily recover where you left off before the buffer was lost.
2. If you were editing a large file and were saving (writing) your text in the buffer periodically, you could recover from an error. For example, consider the following possible circumstances:

You invoked an existing file.
You added some new text (lines).
You saved the additional lines by writing to disk.
You made some changes to some existing lines.
You saved the changes by writing to disk.
You accidentally typed in the delete command by mistake and pressed the Return key. You just "lost" several lines of text.

If you exit (left) the editor and re-invoked it, you would recover the deleted lines and would not have lost the changes made prior to the mistake. If you did not save the previous changes, when you re-invoked the editor you would have to re-enter the changes made before the last write command was entered.

EXITING (LEAVING) THE EDITOR (q)

To leave the ed text editor, save the text you have been working on in the buffer by writing it onto the disk and then type the quit, q, command. For example:

```
w      <CR>
134
q      <CR>
```

The system exits the editor and returns to the shell you were in prior to invoking the editor. For example,

1. If you were in the UNIX shell prior to invoking the editor, the system responds with the prompt character (\$ or #).
2. If you were in the Business Shell menu system, the system returns to the Business Shell menu.

If you attempt to exit the editor without saving (writing) your file, the system responds with a question mark. If you type q again, you exit the editor, and the text in the buffer is lost.

REVIEW EXAMPLES

The following examples review the basic commands of the ed text editor.

Creating a New File

The following example creates a new file named "mtgnotice." You will create a file, edit, and save it on the disk.

Creating the File

```
$ed mtgnotice      <CR>
?mtgnotice
a                  <CR>
DATE: February 14, 1983  <CR>
TO: Department Managers  <CR>
FROM: John Wilson       <CR>
SUBJECT: Scheduling Meeting Notice <CR>
<CR>
<CR>
We will meet on Tuesday, February 15, 1983, <CR>
at 2:00 in the engineering conference room <CR>
to go over the department planning schedules. <CR>
Please bring a copy of department's schedules.<CR>
. <CR>
a <CR>
The meeting will last about 2 hours. <CR>
Each schedule should include man-hour <CR>
requirements, project start and completion <CR>
dates, and other pertinent information. <CR>
<CR>
Don't be late. <CR>
. <CR>
```

Printing the File

```
1,$p <CR>
DATE: February 14, 1983
TO: Department Managers
FROM: John Wilson
SUBJECT: Scheduling Meeting Notice
```

We will meet on Tuesday, February 15, 1983, at 2:00 in the engineering conference room to go over the department planning schedules. Please bring a copy of department's schedules. The meeting will last about 2 hours. Each schedule should include man-hour requirements, project start and completion dates, and other pertinent information.

Don't be late.

Editing the File

After reading the printed version of the screen, you decide to improve the memo by deleting a line -- "Don't be late." Count the line number, starting with the first line and skipping blank lines. Since "Don't be late" is the sixteenth line, you can delete the line as follows:

```
16d <CR>
```

You notice that "department" is misspelled and that "your" is missing in the phrase "bring a copy of department's schedules." The substitute command can fix these errors.

```
9s/department/department/p <CR>
to go over the department planning schedules
10s/of/of your/p <CR>
Please bring a copy of your department's schedules.
```

You decide that the line "The meeting will last about 2 hours" should be the last line of the file. The text that follows needs to be moved above this sentence. Therefore, line 12 through 14 are to be moved after line 10. Moving these lines can be accomplished by the command below:

12,14mlØ <CR>

Dividing the memo into paragraphs makes it easier to read. Add a blank line after a line by entering that line number and the "a" command, for example, 1Øa. Press the Return key twice to create a blank line. Exit with the "." command.

1Øa <CR>
<CR>
. <CR>
14a <CR>
<CR>
. <CR>

Displaying the File

The edited file can now be displayed on the screen by entering:

1,\$p <CR>
DATE: February 14, 1983
TO: Department Managers
FROM: John Wilson
SUBJECT: Scheduling Meeting Notice

We will meet on Tuesday, February 15, 1983, at 2:ØØ in the engineering conference room to go over the department planning schedules. Please bring a copy of your department's schedules.

Each schedule should include man-hour requirements, project start and completion dates, and other pertinent information.

The meeting will last about 2 hours.

you are satisfied with the memo, write it and quit file.

w <CR>
45l
q <CR>

Editing an Existing File

The following example modifies the terminal file (ttys) to change port 6 from a terminal login to a printer login and changes the printer's baud rate to 1200 baud. This is similar to the procedure discussed in Appendix D, Serial Printer and Spooler.

NOTE: Do not change the ttys file. This is just an example.

```
# cd etc <CR>
# ed ttys <CR>
46
l,$p <CR>
12 console
12tty2
12tty3
12tty4
12tty5
12tty6
6s/12/03/p <CR>
03tty6
a <CR>
03lp
. <CR>
. <CR>
03lp
w <CR>
51
q
```

The above example changes the login of port 6 from a terminal to a printer and also changes the baud rate of the printer to 1200 baud (12tty6 to 03tty6). The above example also adds a line to support the printer (03lp). Entering a second period and pressing the Return key causes the editor to display the current line.

ADDITIONAL INFORMATION

This chapter covers the basic functions of the ed text editor. This is enough information for you to create and edit your files adequately for most purposes. If you want to learn more about some of the advanced ed text editor functions, refer to **A User's Guide to the UNIX System** by Thomas and Yates, or to the Bell Laboratories manuals on the ed text editor.

Appendix A. Hard Disk Organization

CONFIGURATION

The built-in internal hard disk on the Altos 586 or ACS 8600 computer systems is configured as follows:

Ten Megabytes (-10)

<u>CYLINDER</u>	<u>USE</u>
0	Bootstrap program
1-40	Swap area
40-41	Alternate-sector area
42-end	XENIX file system

Twenty Megabytes (-12)

<u>CYLINDER</u>	<u>USE</u>
0	Bootstrap program
1-35	Swap area

36-37	Alternate-sector area
38-end	XENIX file system

Thirty-Five Megabytes

<u>CYLINDER</u>	<u>USE</u>
0	Bootstrap program
1-25	Swap area
26-27	Alternate-sector area
28-end	XENIX file system

Forty Megabytes (-14)

<u>CYLINDER</u>	<u>USE</u>
0	Bootstrap program
1-17	Swap area
18-19	Alternate-sector area
20-end	XENIX file system

LOGICAL DEVICES

The following logical devices are defined in the Altos configuration of XENIX.

Logical Devices - Integral Hard Disk

<u>LOGICAL DEVICE</u>	<u>DESCRIPTION</u>
0 hd0	all of hard disk (without sector mapping).
1 hd0a, swap	swap area.
2 hd0b, root	root file system.
3-8	unused.
9 hd0.spares	spare blocks for alternate sector mapping.
10	future expansion.
11 hd0.track0	all of track 0.
12 hd0.boot	primary bootstrap on track 0.
13 hd0.roc0	rest of cylinder 0. (Consists of cylinder 0 except for track 0.) Used for <u>fsck</u> temporary file.
14 hd0.layout	layout information (see <u>layout</u> (1)).
15 hd0.secmap	mapping information for alternate sectors (see <u>map</u> (1)).

Logical Devices - Additional Hard Disk

<u>LOGICAL DEVICE</u>	<u>DESCRIPTION</u>
16 hd1	all of hard disk (without sector mapping).
17 hd1a	additional file system.
25 hd1.spares	spare blocks for alternate sector mapping.
27 hd1.track0	all of track 0.

Logical Devices - Additional Hard Disk (cont.)

<u>LOGICAL DEVICE</u>	<u>DESCRIPTION</u>
30 hdl.layout	layout information (see layout (1)).
31 hdl.secmap	mapping information for alternate sectors (see map (1)).

Appendix B.

Floppy Diskette Organization

CONFIGURATION

586

The floppy disk organization for a bootable XENIX File System is as follows:

<u>TRACK</u>	<u>USE</u>
0-54	XENIX file system
55-end	Swap area

ACS 8600

The floppy disk organization for a bootable XENIX File System is as follows:

<u>TRACK</u>	<u>USE</u>
0	Bootstrap program
1	Unused
2	Swap area
3-end	Xenix file system

LOGICAL DEVICES

586

The following logical devices are defined in the Altos configuration of XENIX:

<u>LOGICAL DEVICE</u>	<u>TRACK</u>	<u>DEFINITION</u>
fd0 (block count=1440)	0-end	"Pseudo-tape" (see below), or file system
fd0.swap	55-end	swap area

ACS 8600

The following logical devices are defined in the ALTOS configuration of XENIX:

<u>LOGICAL DEVICE</u>	<u>TRACK</u>	<u>DEFINITION</u>
fd0.dd (block count=900)	2-end	"Pseudo-tape" (single-sided, double density, see below)
fd0.swap	2	Swap area (double density)
fd0.root	3-end	File System (double density)
fd0.boot	0	Bootstrap (single density)
fd0.sd (block count=500)	0-end	Standard IBM format (single density)

Double-Sided Drive

If you have an ACS 8600 with a double-sided double-density diskette drive, you may refer to it as follows:

<u>Device Name</u>	<u>Device Numbers Major/Minor</u>	<u>Definition</u>
fd0.2s (block count=2250)	1/7	Cylinders 2-77, double-sided, double-density 512-byte sectors.

Appendix C.

Cartridge Tape Organization

The add-on cartridge tape drive for the ACS 8600 computer system has the following characteristics:

MEDIA

Scotch(r) DC 300XL data cartridge or equivalent.

SPECIFICATIONS

Four tracks; capacity is approximately three megabytes per track, twelve megabytes per tape.

The approximate capacity is calculated assuming a four-kilobyte block size.

CONFIGURATION

There are no predefined allocations or special uses of any portion of the cartridge tape.

All four tracks are treated as contiguous; that is, the tape appears to be a single track, twelve megabytes in length.

A single logical device is defined for cartridge tape access:

ACS 8600

<u>LOGICAL DEVICE</u>	<u>DEVICE NUMBER</u>	
	<u>MAJOR</u>	<u>MINOR</u>
ct0	5	0

586

<u>LOGICAL DEVICE</u>	<u>DEVICE NUMBER</u>	
	<u>MAJOR</u>	<u>MINOR</u>
ct	2	0
rct	5	0
nct	2	128
nrct	5	128

Appendix D.

Serial Line Printer And Spooler

STANDARD PRINTER CONFIGURATION

In the Altos implementation of XENIX, serial port 6 of the 586 system, or serial port 8 of the ACS 8600 system is configured for a serial printer operating at 9600 baud. The logical device name "/dev/lp" may be used to refer to this port, and the `lpr` utility references this device automatically for printing and spooling.

The `lpr` utility assumes that only one printer, /dev/lp, is attached to the system. If you want to connect more than one printer, refer to the "Connecting More Than One Printer" section of this appendix.

Printer spooling is a technique that mediates printer activity in a manner that allows all users of the system to share a printer without conflict. Files to be printed are copied to a spool directory (/usr/spool/lpd) and a background process moves those copies to the line printer device. This device is found in /dev, and is called "lp" (lp1, lp2, etc). Files in /dev are known as "special files," and are the interface to UNIX I/O. For an expanded discussion of special files in specific and I/O in general, see

sections 29 through 32 of the **UNIX Programmer's Manual**, Volume 2B. A great deal of this material is specific to the PDP-11; however, the mechanisms are the same as those for the Altos computer system.

Any of several programs may be used to copy material to printer devices. For example:

```
cat /usr/john/doc > /dev/lp
```

This command copies the file "/usr/john/doc" directly to the default printer. If you have more than one printer, the default printer is the one that is most used. This has three possibly undesirable effects:

1. If /usr/john/doc is a big file, this command may take some time to complete.
2. If another user is copying a file to the printer at the same time, the result is probably not what anyone intended.
3. Since the `cat` program knows nothing about printers, and therefore nothing about baud rates, page sizes, margins, etc., the result may not be what is expected.

The `lpr` utility program is used to control printer requests. This program knows something about printers, how to set baud rates, etc.

invoke the `lpr` utility, enter:

```
lprN [file_list]
```

Where: "N" is a digit from 0 to 9 and selects one of n up to 8 printers.

`lpr` may be invoked without entering a value for "N" by entering:

```
lpr - bname [file_list]
```

This command assumes the default printer, and supplies a banner page for each file in `file_list`. Unlike previous versions of `lpr`, the banner page is not supplied as the default. The "-b" option is used to turn on the generation of a banner. The -b option has one other effect: if it is present, the printer will

eject a page before printing a banner page, and will not eject a page after the file is completely printed. In a similar fashion, the default will produce a formfeed after the file is printed, and not before. This action is to aid users of slow or character printers.

HARDWARE CONNECTIONS

The connection between the Altos computer system and a printer is a cable which has 25-pin subminiature D-type connectors. The computer's port hardware is "female," which requires that the computer side of a cable have a "male" connector. Most printers also have "female" port connectors; a compatible cable should have a "male" connector on each end. The most commonly-used cables have at least pins 2, 3, and 20 connected from end to end.

Printer control of computer output is accomplished by controlling the RS232C DTR (signal 20) signal. Be sure that the cable which connects the printer and the computer has this conductor.

Note that the printer should be configured to use the X-ON, X-OFF protocol.

CONNECTING MORE THAN ONE PRINTER

If you want to connect more than one printer, you should:

1. Log in as super-user (root).
2. You need to create appropriate device files in /dev. This is done with the `ln` command. First, select which printer is to be the default printer. This printer should be the most-used printer in the system, and may be either serial or parallel. A parallel printer (ACS 8600 only) requires no further configuration. See Appendix E for parallel line printer instructions.

To make the default printer device available for reassignment, enter:

```
mv /dev/lp /dev/olp
```

Next, select the port to which this printer is to be connected, by entering:

```
ln /dev/ttyP /dev/lp
```

To make the parallel printer the default printer, enter

```
ln/dev/plp /dev/p
```

If a serial printer is to be the default printer, select the connecting port.

Next, configure the system for the additional printers to be supported, selecting which printer number (1-7) they are to be, and the number of the serial port to which they are to be connected, and enter:

```
ln /dev/ttyP /dev/lpN
```

Where "P" is the serial port number, and "N" is the printer number. It is suggested that "P" and "N" be the same number to alleviate the confusion that occurs when printer 5 is connected to port 3.

Next, repeat the above `ln` command for each printer to be supported. If the parallel printer (ACS 8600 only) is not to be the default, enter:

```
ln/dev/plp /dev/lpN
```

Where "N" is the printer number of the parallel printer.

3. You need to make file names for invoking the lpr program. For each printer device file made in the previous step, enter:

```
ln /bin/lpr /bin/lprN
```

Where: "N" is a printer number.

4. You need to create spool directories. These directories are used to hold copies of material to be printed for each printer. For each printer device file made, enter:

```
mkdir /usr/spool/lpdN
```

Where: "N", as above, is a printer number.

NOTE: The default directory is already installed, do not try to create it. If any of the printers have baud rates other than 9600, refer to the next section, Changing/Setting Baud Rates.

CHANGING/SETTING BAUD RATES

If you want to change or set a terminal or printer to a different baud rate than 9600, you should perform the following steps.

The `/etc/ttys` file contains entries of the form:

```
l2ttyP
```

The above line is interpreted by various system programs. The first digit ("1" in the above example) tells the system to attempt to log on ttyP ("P" is a serial port number). The second digit specifies the baud rate for that particular terminal (see Baud Rate list below or `GETTY(8)` in volume I of the **UNIX Programmer's Manual** for the baud rates associated with these values.) For each printer to be supported, type a "disable" command for the corresponding serial port. This ensures that the system will not attempt to log on a port which is dedicated to a printer.

For example, if a printer is set up for port 6, as super-user enter:

```
||| disable tty6
```

Now, for each printer to be supported, add a line to file `/etc/ttys` that has the following format:

```
||| 0B1pN
```

This line may be anywhere in the file. No spaces are permitted between portions of the line. "B" is a baud rate argument from the list below. "N" is the printer number.

If the default printer's baud rate is other than 9600, add:

```
0B1p
```

NOTE

Printers whose baud rate is 9600 do not require a corresponding line in `/etc/ttys`.

Baud Rates

<u>"B" VALUES</u>	<u>BAUD RATE</u>
0	300
1	150
2	9600
3	1200
5	300
6	2400
7	4800

CONFIGURING SYSTEM WITHOUT A PRINTER

If you wish to support six terminals (with no printer), you should:

1. Log in as super-user (root).
2. Remove the lp entry in /dev by entering

```
rm /dev/lp<CR>
```

3. Enable the login and shell on port 6 (586) or 8 (8600) before becoming multiuser by 1) editing the line referencing tty6 or tty8 in the file /etc/ttys from "02tty6" to "12tty6" for the 586, or "02tty8" to "12tty8" for the 8600; or 2) by using the Port Configuration utility via the Altos Business Shell.

SERIAL PRINTER SET UP FOR APPLICATIONS THAT DO NOT USE THE LINE PRINTER SPOOLER

Setmode is a program that supports printers requiring a baud rate setting other than 9600, or tty nodes other than default. If a single printer at 9600 is used, no further configuration of the system is required.

Setmode can also accept a list of tty modes, similar to those which would be given to the stty(1) utility. Serial baud is itself a tty mode. Other tty modes relating to printer use are tab expansion and action on newline. Delays for newline and formfeed may be programmed with this technique as well as control flow protocols, such as XON-XOFF. The full invocation of setmode is:

```
/usr/bin/setmode devicename modelist
```

Most uses of setmode are simply to change serial baud. If a single serial printer at a baud rate other than 9600 is desired, a single configuration step is needed. The configurer should login as root and invoke the setmode program as:

```
|| /user/bin/setmode /dev/lp baud
```

where "baud" is one of: 110 300 1200 2400 4800 9600.

An example... for a 1200 baud printer:

```
|| /usr/bin/setmode /dev/lp 1200
```

The change of baud rate takes immediate effect and remains in effect until the system is brought down. A simple way to test the baud rate change is to enter:

```
cat /etc/passwd > /dev/lp
```

If the password file comes out on the printer in good order, the change was effective. Problems at this stage could be 1) that the parity setting is wrong on the printer (should be disabled), or 2) that the printer was not set for linefeed on carriage return, or 3) the printer was not configured to use the X-ON, X-OFF protocol. Please consult your printer manual for these settings.

A convenient place to have this done automatically is to place the "setmode" line in the /etc/rc file as the last line.

```
/usr/bin/setmode /dev/lp 1200
```

Adding the above or similar line to the /etc/rc file is best accomplished with one of the system editors. DO NOT, HOWEVER, ATTEMPT TO USE THE ALTOS WORD PROCESSOR (SELECT). Please consult the XENIX editor documentation for the invocation and use of the ed, ex, or vi editor.

If multiple printers at possibly varying baud rates are required, a more complex configuration session is required. Four steps are required:

For each printer to be supported, make an appropriate device files:

```
/etc/mknod /dev/lpN c 0 N-1
```

"N" is the number of the serial port assigned to a particular printer. "N-1" means the port number minus 1.

2. For each serial port dedicated to a printer, disable login:

```
/usr/bin/disable ttyN
```

3. For each printer at other than 9600 baud, set the baud rate:

```
/usr/bin/setmode /dev/lpN baud
```

this may be done in an automatic fashion, as described above.

4. Modify the /usr/lib/BB3/IPLINPUT file to reflect the installed printers (if modification is needed for the Altos Accountant Package).

Appendix E.

Parallel Line Printer And Spooler

In the Altos distribution of XENIX, serial port 8 of the ACS 8600 computer system is configured for a serial printer operating at 9600 baud. The logical device name /dev/lp may be used to refer to this port, and the lpr utility references this device automatically for printing and spooling.

The logical device /dev/plp can be used to reference the parallel port with a Centronics-type interface. It is possible to have both a serial and a parallel printer attached to the system.

To use the lpr utility with a parallel printer:

- 1) Log in as super-user (root or admin).
- 2) Enter the following commands:

```
cd /dev
mv lp olp
mv plp lp
```

This renames the parallel printer device as "lp".

NOTE

If you intend to set up more than one printer, do not perform the above steps. Refer to the Connecting More Than One Printer section in Appendix D for instructions.

For information on serial line printers, hardware connections, or changing/setting baud rates, refer to Appendix D, Serial Line Printer and Spooler. Refer to the **Altos 586** or **ACS 8600 Operator's Guide** for information on setting up printer cables.

Appendix F.

List of Terminal Capabilities

The basic XENIX system works with nearly all generally available terminals by making use of a standard "lowest common denominator" of terminal capabilities. However, some of the XENIX utilities, including many especially useful utilities, can make use of special terminal capabilities. A major example is the Business Shell. See the Configuring the Ports section in Chapter 7.

For this reason, the /etc/termcap data base has been developed to describe terminal capabilities. The following pages give essential information extracted from /etc/termcap in a form more easily understood than when the file itself is viewed. The information given describes all terminals currently supported for special use by the Altos release of the XENIX operating system.

CUSTOMIZING YOUR ALTOS XENIX SYSTEM

The following information explains how to inform XENIX of the special capabilities of the terminals you are using with the system.

The XENIX utilities, such as the Business Shell, that make use of special terminal capabilities access the file `/etc/ttytype`, which defines the type of the terminal attached to each serial port. It may be necessary to edit this file to provide the correct terminal type for each port. Each line in `/etc/ttytype` has two fields -- the terminal type, and the associated port number.

The "terminal type" used in `/etc/ttytype` is the second field of the appropriate terminal entry in the `/etc/termcap` data base; that is, it is between the first two vertical bars, "|", in the entry. On the following list of "Terminals Supported by the XENIX Operating System," the entry called "name of terminal" is the proper reference. When editing `/etc/ttytype`, use that name as the "terminal type." Any editor that is convenient can be used. Change the terminal type, if necessary, for each active serial port that your system uses.

For example, you are using a TeleVideo terminal, current model 920. When you consult the following list, you will find a group of entries for Televideo. The appropriate entry is "920b." Editing `/etc/ttytype`, you find that all ports are associated with "wyse." Change the port assignments you are using, or all port assignments, to "920b" and update the file.

If you do not find a listing for the terminal you are using, consult your dealer or Altos Customer Support.

TERMINALS SUPPORTED BY THE XENIX OPERATING SYSTEM

The material below is derived from the system file /etc/termcap. This file describes terminal capabilities and characteristics. The use of this file is to support screen-oriented programs, such as vi. The /etc/termcap file is composed of a description entry for each supported terminal (and sometimes more than one, if the terminal has options, or is part of a family of products).

This document cites the name by which a particular terminal is known to the system, and contains a short description of the terminal, including the manufacturer's name, and other useful information. Included are comments relevant to the use of the terminal.

an example:

```
wyse                WYSE WY-100
this entry indicates that the WYSE WY-100 terminal
is supported by the system and that its name is
"wyse" (case is significant).
```

After having selected the "name" of your terminal from the following pages, you need to specify the name to several system programs. Depending on which shell you are in, enter:

If you are in the UNIX Shell:

```
||| TERM = name; export TERM <CR>
```

where name = name of your terminal from /etc/termcap file.

```
||| or
||| pconfig <CR>
```

If you are in the C Shell (Optional):

```
||| setenv TERM name <CR>
```

where name = name of your terminal from /etc/termcap file.

If you are in the Business Shell:

Log in as **admin**.

Select the Port Configuration selection under the Master Control Services menu or under the System Administration menu of the Business Shell.

See the Configuring the Ports section in Chapter 7 for additional information.

Terminal naming conventions:

Terminal names look like:

`<manufacturer> <model> - <modes/options>`

Certain abbreviations (for example, `cl00` for `conceptl00`) are also allowed for upward compatibility. The part to the left of the dash, if a dash is present, describes the particular hardware of the terminal. The part to the right is used for flags indicating special ROMs, extra memory, particular terminal modes, or user preferences. Names are always in lower-case, for consistency in typing.

The following are conventionally used for flags:

`rv` Terminal in reverse video mode (black and white)
`2p` Has two pages of memory. Likewise `4p`, `8p`, etc.
`w` Wide - in 132 column mode.
`pp` Has a printer port which is used.
`na` No arrow keys - termcap ignores arrow keys which are actually there on the terminal, so the user can use the arrow keys locally.

Special manufacturer codes:

`A`: hardcopy daisy wheel terminals
`M`: Misc. (with only a few terminals)
`q`: Homemade
`s`: special (dialup, etc.)

The terminals:

<u>NAME OF TERMINAL</u>	<u>DESCRIPTION</u>
wyse	WYSE WY-100
du	dialup
hp	Hewlett-Packard
2621-nl	HP 2621 with no labels
2621	HP 2621
2621-wl	HP 2621 w/labels
hl9-u	Heathkit with underscore cursor
hl9-us	Heathkit w/keypad shifted/underscore cursor
hl9-bs	Heathkit w/keypad shifted
hl9	Heathkit hl9
cl00-rvs	slow reverse Concept 100
cl00-s	slow Concept 100
cl00-rvna	cl00 with no arrows
cl00-rvpp	cl00 with printer port
cl00	Concept 100
cl00-rv	cl00 rev video
adm3a	LSI ADM3A
adm3	LSI ADM3
mime	Microterm M1m1
bg	BBN BitGraph terminal
vt52	DEC VT52
gigi	DEC GIGI

A: DAISY WHEEL PRINTERS

The A manufacturer represents Diablo, DTC, Xerox, Qume and other Daisy wheel terminals.

1620	Diablo 1620
1620-m8	Diablo 1620 w/8 column left margin
dtc	DTC 382 with VDU
dtc300s	DTC 300s
gsi	
aj830	Anderson Jacobson
5520	NEC Spinwriter 5520
qume5	Qume Sprint 5
xl720	Xerox 1720 same as the Diablo 1620

C: CONTROL DATA

cdc456	CDC
cdc456tst	CDC

D: DATAMEDIA

dml520	Datamedia 1520
dm2500	Datamedia 2500
dm3025	Datamedia 3025a
3045	Datamedia 3045a
dt80	Datamedia dt80/1
dt80w	Datamedia dt80/1 in 132 char mode

H: HAZELTINE

hl000	Hazeltine 1000
hl552	Hazeltine 1552
(be sure auto lf/cr switch is set to cr)	
hl552rv	Hazeltine 1552 reverse video
hl420	Hazeltine 1420
hl500	Hazeltine 1500
hl510	Hazeltine 1510
hl520	Hazeltine 1520
h2000	Hazeltine 2000

I: IBM, INTERACTIVE SYSTEMS, AND INTECOLOR

8001	ISC8001 Compucolor/Intecolor
compucolor2	CompucolorII
intest	Interactive Systems Corporation
(modified PE Owl 12000)	
ibm	IBM 3101-10

M: MISCELLANEOUS TERMINALS

tab132	TAB 132/15
tab132w	TAB 132/15
tab132rv	TAB 132/15
tab132wrv	TAB 132/15

mw2	Multiwriter 2
trs80	TRS-80 Radio Shack Model I
d800	Direct 800/A
vc404	Volker-Craig 404
vc404s	Volker-Craig 404 w/standout mode
vc404na	Volker-Craig 404 w/no arrow keys
vc404sna	Volker-Craig 404 w/standout mode and no arrow keys
vc303a	Volker-Craig 303A
vc303	Volker-Craig 303
ampex	Ampex Dialogue 80
d132	Diagraphix 132a
soroc	Soroc 120
tec400	TEC scope
tec500	TEC 500
tec	
teletec	Teletec Datascreen
digilog	Digilog 333
ep48	Execuport 4080
terminet1200	GE Terminet 1200
aed512	AED 512
datapoint	Datapoint 3360
falco	Falco TS-1
dg	Data General 6053
cdi	CDI 1203
(^S is an arrow key. not recommended for use)	
sol	
xl83	Cybernex XL-83
omron	Omron 8025AG
plasma	Plasma Panel
swtp	Southwest Technical Products CT82
terak	Terak emulating Datamedia 1520
virtual	CB unix virtual terminal
delta	Delta Data 5000
mdl110	Cybernex MDL-110
zen30	Zentec 30

N: ANN ARBOR

aa	Ann Arbor 4080
aaa-18	Ann Arbor Ambassador/18 lines
aaa-20	Ann Arbor Ambassador/20 lines
aaa-22	Ann Arbor Ambassador/22 lines
aaa-24	Ann Arbor Ambassador/24 lines
aaa-26	Ann Arbor Ambassador/26 lines
aaa-28	Ann Arbor Ambassador/28 lines
aaa-30	Ann Arbor Ambassador/30 lines
aaa-36	Ann Arbor Ambassador/36 lines
aaa-40	Ann Arbor Ambassador/40 lines
aaa-48	Ann Arbor Ambassador/48 lines

aaa-60 Ann Arbor Ambassador/60 lines
aaa Ann Arbor Ambassador
aaa-db Ann Arbor Ambassador 30
(destructive backspace)

T: TELETYPE

33 Model 33 Teletype
43 Model 43 Teletype
37 Model 37 Teletype

V: VISUAL

vi200 Visual 200 with function keys
vi200-rvic Visual 200 revers video using
insert character
vi200-f Visual 200 no function keys
vi200-rv Visual 200 reverse video
vi200-ic Visual 200 using insert character

X: TEKTRONIX

tek Tektronix 4012
tek4013 Tektronix 4013
tek4014 Tektronix 4014
tek4015 Tektronix 4015
tek4014-sm Tektronix 4014 in small font
tek4015-sm Tektronix 4015 in small font
tek4023 Tektronix 4023
4025 Tektronix 4024/4025/4027
4025-17 Tektronix 4025 17 line window
4025-17ws Tektronix 4025 17 line window in
workspace
4025ex Tektronix 4025 w/!

a: ADDS

Regent: lowest common denominator, works on all
regents.

regent ADDS Regent Series - works on all
of series.
regent100 ADDS Regent 100
regent20 ADDS Regent 20
regent25 ADDS Regent 25
regent40 ADDS Regent 40
regent60 ADDS Regent 60
regent60na ADDS Regent 60 w/no arrow keys
a980 ADDS Consul 980

Note: If return acts strangely on a980, check
internal switch 2 on the top chip on the Control PC
board.

viewpoint ADDS Consul 980

b: BEEHIVE

sb2	fixed Super Bee
bh3m	BeehiveIIIm
superbeeic	Super Bee with insert character
microb	Micro Bee series
sb1	Beehive Super Bee - f1=escape, f2=^C.

c: CONCEPT (HUMAN DESIGNED SYSTEMS)

There are different versions of the Cl08 PROMs. The first one would lock out the keyboard if you sent lots of short lines (like /usr/dict/words) at 9600 baud. Try that on your Cl08, and see if it sends a ^S when you type it. If so, you have an old version of the PROMs. The old one also jumbled the vi editor with a 132-character line-length. You should configure the Cl08 to send ^S/^Q before running the vi editor.

cl08	Concept l08 w/8 pages and ^S/^Q
cl08	Concept l08 w/4 pages and ^S/^Q

Concepts have only window-relative cursor addressing, not screen relative. A one-page window scheme is necessary for screen style programs.

d: DEC (DIGITAL EQUIPMENT CORPORATION)

It is assumed that you have smooth scroll off, or are at a slow enough baud rate that it doesn't matter (1200 or less). Also, this assumes that you set auto-nl to on; if you set it off, use "vt100-nam."

The xon/off switch should be on.

vt100	DEC VT100
vt100	VT100 w/no am
gt42	DEC GT42
vt132	VT132
gt40	DEC GT40
vt50	DEC VT50
dw1	Decwriter I
vt50h	DEC VT50h
ovt100	old DEC VT100
vt100-s	DEC VT100 132 cols 14 lines w/o advanced video option)
vt100-w	DEC VT100 132 cols (w/advanced video)
dw2	Decwriter II
dw4	Decwriter IV

h: HEWLETT PACKARD

2621-A	2621 w/new ROM, strap A set
2621-45	HP 2621 with 45 keyboard
	(should be used at 4800 baud or less)
hp2645	HP 264x series
hp2626	HP 2626
	(should be used at 4800 baud or less)
hp2648	HP 2648a graphics terminal
2640	HP 2640a
2640b	HP 264x series
2621-48	HP 48 line 2621
2621-nt	HP 2621 w/no tabs
	(2621 with no labels ever)

i: INFOTON (GENERAL TERMINAL)

il00	General Terminal l00A
	(formerly Infoton l00)
i400	Infoton 400
addrinfo	
infotonKAS	

k: HEATHKIT (ZENITH)

hl9-a	Heathkit H19 ANSI mode
-------	------------------------

l: LEAR SIEGLER (ADM)

If your adm31 terminal is not functioning properly, ensure that the DIP switch in position 6 is set to OFF. If there is no DIP switch, you have an old adm31 and you should see the entry for "oadm31."

adm31	LSI adm31
adm2	LSI adm2
adm42	LSI adm42
adm5	LSI adm5
adm3a+	ADM3A PLUS
oadm31	old ADM31

m: MICRTOTERM

These mime1 entries refer to the Microterm Mime I or Mime II. The default mime is assumed to be in enhanced act iv mode.

mime3a	Mime1 emulating 3a
microterm	Microterm Act IV
microterm5	Microterm Act V
act5s	skinny act5 - Act V in split screen mode
mime-fb	full bright Mime1
mime-hb	half bright Mime1

```

mime2a-s          Microterm Mime2a
                  (emulating an enhanced Soroc IQ120)
                  (but ^X can't be used as a kill character)
mime2a           Microterm Mime2a
                  (emulating an enhanced vt52)
mime-3ax         Mimet1 emulating enhanced 3a

```

p: PERKIN ELMER

```

pe550           Perkin-Elmer 550
fox             Perkin-Elmer 1100
owl            Perkin-Elmer 1200

```

s: SPECIALS

Special terminals are used to label tty lines when you don't know the kind of terminal on the line. The characteristics of an unknown terminal are the "lowest common denominator": they resemble a TI 700.

```

arpanet        network
bussiplexer    network
ethernet       network
lpr            lineprinter
dumb           unknown
switch        intelligent switch

```

t: TEXAS INSTRUMENTS

```

ti             TI Silent 700
ti745         TI Silent 745
ti800         TI Omni 800

```

v: TELEVIDEO

Note: The 912 has a <funct> key that functions as a normal shift key: <funct>8 xmits "^A8/r." The 920 has this plus real function keys that transmit different signals. Termcap makes you use the funct key on the 912 but the real keys on the 920.

```

tvi912        TVI920 old TeleVideo
912b         TVI new TeleVideo 912
920b         TVI new TeleVideo 920
tvi912-2p    TeleVideo w/2 pages
              set to page 1 when entering ex or
              vi.
              reset to page 0 when exiting ex or
              vi.
tvi950-ap    TVI 950 w/alt pages
tvi950-b     bare TVI 950 no is
tvi950-ns    TVI 950 w/no standout

```

Note: The following TVI descriptions are for all 950's. It sets the following attributes:

full duplex
write protect off
conversation mode
graphics mode off
white on black
auto page flip off
turn off status line
clear status line
normal video
monitor mode off
edit mode
load blank character to space
line edit mode
enable buffer control
protect mode off
local edit keys
program unshifted send key to send line all
program shifted send key to send line unprotected

set the following to nulls:
field delimiter
line delimiter
start-protected field delimiter
end-protected field delimiter

set end of text delimiter to carriage return/null
clear all column tabs

tvi950 TeleVideo 950

Note: tvi950 sets duplicate (send) edit keys (\E1) when entering vi and sets local (no send) edit keys (\EK) when exiting vi

tvi950-2p TeleVideo 950 w/2 pages

Note: The tvi950-2p entry is for a 950 (with two pages) which has the following characteristics:

set 48 line page
place cursor at page 0, line 24, column 1
when entering ex or vi, set 24 line page
when exiting ex or vi, reset 48 line page,
place cursor at 0,24,1

tvi950-4p TeleVideo 950 w/4 pages

Note: The tvi950-4p entry is for a 950 terminal (with four pages) which has the following characteristics:

set 96 line page
place cursor at page 0, line 24, column 1
when entering ex or vi, set 24 line page
when exiting ex or vi, reset 96 line page
place cursor at 0,24,1

tvi950-rv	TeleVideo 950 rev video
tvi950-rv2p	TeleVideo 950 rev video w/2 pages
tvi950-rv4p	TeleVideo 950 rev video w/4 pages

y: TELERAY

t3700	dumb Teleray 3700
t3800	Teleray 3800 series
t1061	Teleray 1061
t1061f	Teleray 1061 with fast PROM

Appendix G.

Sample Listing of Xenix Run-Time Utilities

The following is a sample listing of the utilities provided in a XENIX Run-Time System. Most of these utilities can be accessed via the Business Shell menus.

You can obtain a list of your XENIX operating system's utilities by entering:

```
login: root
# cd / <CR>
# ls -FCR | lpr <CR>
```

Sample List Of XENIX Run-Time Utilities

bin	lib	lost+found	make.hd	usr
etc	load.hd	make.floppy	tmp	
./bin:				
awk	df	ln	passwd	su
bsh	du	login	ps	sync
cat	echo	lpr	pwd	tar
chgrp	ed	ls	rm	test
chmod	expr	mail	rmdir	true

Sample List of XENIX Run-Time Utilities (Cont)

```

chown      find      map      sh      tty
cp         fsck     mkdir   sizefs  who
date      kill     multiuser  sleep
dd        layout  mv      stty

./dev:
console   hd0.secmap  null      rhd0.track0  tty3
ct**     hd0.spares  rct**    rhd0a        tty4
ct0*    hd0.track   rfd0     rhd0b        tty5
fd0     hd0a       rfdl     root         tty6
fd0.swap hd0b      rhd0     rroot        tty7*
fdl     kmem      rhd0.boot  rswap       tty8*
hd0     lp        rhd0.layout  swap
hd0.boot mem      rhd0.roc0  tar
hd0.layout nct**   rhd0.secmap  tty
hd0.roc0 nrct**  rhd0.spares  tty2

./etc:
asktime   init      mount     systemid    utmp
checklist menusys.bin mtab      termcap     wall
getty     mfs      newuser   ttys
group     mkfs     passwd    ttytype
haltsys   mknod    rc        umount
inir      motd     shutdown  update

./etc/newuser:

./lib:
remove.this

./lost+found:
remove.this

./tmp:
remove.this

./usr:
adm  altos  bin  lib  spool  src  sys  tmp  unix  user

./usr/adm:
messages  msgbuf  wtmp

./usr/altos:
qa.test

./usr/bin:
Mail  disable  enable  fcopy  format  more  reset  ua

```

*ACS 8600 only
 **586 only

Sample List of XENIX Run-Time Utilities (Cont)

```
./usr/lib:
Mail.help      bsh          fmt          more.help
Mail.help      bsh.messages lpd
```

```
./usr/spool
lpd      mail
```

```
./usr/spool/lpd:
remove.this
```

```
./usr/spool/mail:
remove.this
```

```
./usr/src:
cmd
```

```
./usr/src/cmd:
```

```
./usr/sys:
remove.this
```

```
./usr/tmp:
remove.this
```

```
./usr/unix:
```

```
./usr/user:
```

Appendix H.

File Transfer Program

The file transfer programs described in this appendix are used to transfer ASCII text files or binary data files from XENIX-to-XENIX, MP/M-to-XENIX, and XENIX-to-MP/M on Altos computer systems. These programs should be used only by those readers who are familiar with XENIX and MP/M.

The programs do NOT convert MP/M programs to XENIX compatible programs or XENIX programs to MP/M programs. They simply allow the transfer of files between the two systems. Also, slight variations in program execution are required when transferring ASCII text files as opposed to binary data files.

Note that, the programs do not provide error detection or correction during file transfers.

Refer to the chart below to determine the appropriate file transfer procedure.

WITH SENDER OPERATING SYSTEM	WITH RECEIVER OPERATING SYSTEM	USE PROCEDURE
CP/M - MP/M	XENIX <u>prior</u> to ACS 8600 XENIX Version 2.2d; <u>prior</u> to Altos 586 Version 2.3	A
CP/M - MP/M	XENIX - <u>prior</u> to ACS 8600 XENIX Version 2.2d; <u>prior</u> to Altos 586 Version 2.3	B
XENIX	XENIX	C
XENIX	CP/M - MP/M	D

NOTE

ACS 8600 versions 2.2d and Altos 586 versions 2.3 and higher have the XENIX ftp utility.

PROCEDURE A

Description

NOTE

This utility is to be used only for ACS 8600 computers with XENIX versions prior to Version 2.2d, and for ALTOS 586 computers with XENIX versions prior to 2.3.

This utility can be used to transfer files from the ACS 8000 system with CP/M-MP/M to the ACS 8600 or Altos 586 with XENIX.

Two diskettes are included with this document. One of the diskettes is an MP/M single-density diskette (labelled TOXENIX.COM). This diskette contains the following files:

TOXENIX.COM - This program passes commands to the ALTOS 586 or ACS 8600 before and after each file transfer. These commands are interpreted and acted upon by the cu program on the ALTOS 586 (see cu(1) section of the XENIX manual for more information).

TOXENIX.C - This is the source for the TOXENIX program (it was compiled using Supersoft's C compiler).

FILETRAN.DOC - This is a copy of this document.

The second diskette is a XENIX double-density diskette in tar format (labelled /usr/bin/decode). This diskette contains the following files:

/usr/bin/decode - This program is used to decode binary data files which were transferred using the -B option of the TOXENIX program. It is not used if only text files are transferred.

/usr/src/cmd/decode.c - This is the source for the decode program.

NOTE

If you have a hard disk MP/M system, use the PIP utility to copy the three MP/M files to the hard disk. For your XENIX system, use tar to copy the files to hard disk.

Step-by-Step Instructions

1. Use a "null modem" cable to connect a terminal port on the ALTOS 586 to a port on the ALTOS 8000 system. Any ports may be connected; however, in the discussion which follows, it is assumed that port 6 (i.e., the line printer port) on the ALTOS 586 or port 8 on the ACS 8600 is connected to console port 3 (JU) on the ALTOS 8000. The following RS-232 pins must be connected in the cable between these two ports:

ALTOS 8000 end	ALTOS 586 or ACS 8600 end
-----	-----
Pin 1	Pin 1
Pin 2	Pin 3
Pin 3	Pin 2
Pin 6	Pin 20
Pin 7	Pin 7
Pin 8	Pin 8
Pin 20	Pin 6

2. Connect your terminal to console port 1 (JX) of your ALTOS 8000 system. Boot the ALTOS 8000 system, and run the MPMSETUP program. Consult ALTOS MP/M documentation for a detailed description of this program and its operation. The baud rate of console port 3 (JU) must be set to 1200 baud. After a new copy of the operating system has been written to the disk, the system must be re-booted for the new baud rate to take effect.
3. Insert the diskette labelled "TOXENIX.COM" into the floppy drive on the ALTOS 8000 system, and use the PIP command to copy the program to your hard disk or to your master floppy.
4. Disconnect your terminal from the ALTOS 8000 system, and connect it to port 1 on your ALTOS 586 or ACS 8600 system. Boot XENIX, and bring it up multi-user. (See the XENIX installation instructions if you don't know how to do this).
5. Enter the following commands on your XENIX system:

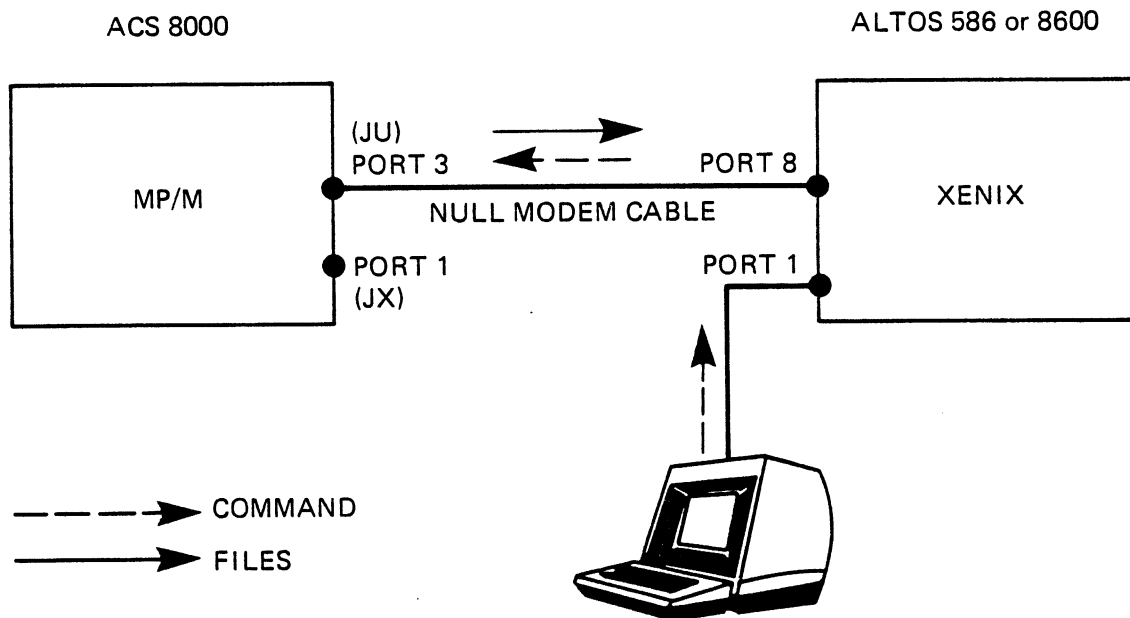

NOTE: PORT 6 of the ALTOS 586;
PORT 8 of the ACS 8600

NOTE: PORT 6 of the ALTOS 586;
PORT 8 of the ACS 8600

Figure H-1. File Transfer Cable Configuration

NOTE

You must enter commands exactly as they are shown below, with spaces where they are shown. In particular, you **MUST** use spaces to separate each of the parameters on the **cu** command line. If spaces are not used, the **cu** program will accept the command, but will not function properly. In addition, all system prompts are printed in lightface type and user input is printed in boldface type.

\$ su<CR> Comment: This is super-user status so please be careful.

Instruction: Insert the diskette labelled "/usr/bin/decode" in the floppy drive immediately before entering the next command.

```
# tar xv<CR>
# chmod 666 /dev/tty<CR>
# <CTRL-D>
$ cu -t -s 1200 -a /dev/null -l /dev/tty<CR>
```

where: n=8 for the ACS 8600; 6 for the Altos 586

The message "Connected" should be displayed on your screen. Type the RETURN key. The standard MP/M connection message "3A>" should be displayed. If nothing happens, your cable is built incorrectly, or the **cu** command was not entered properly. If garbage is displayed, the baud rate was probably not set correctly.

NOTE

Every line that you type from this point onward is passed to the MP/M system through the XENIX system. Hence, you will see MP/M prompts displayed on your screen, even though your console is connected directly to the XENIX system. See Figure H-1.

To read files owned by a specific user you must enter the appropriate USER command. In the example given below the current user is changed from three to zero.

```
3A> USER 0
0A>
```

7. The TOXENIX.COM program can now be used to transfer one or more files from MP/M to XENIX. To send ASCII text files, use the MP/M command:

```
ØA> TOXENIX file1 ... fileN
```

File names are full MP/M file names with spaces separating the files if there are more than one.

To send binary data files, use the command:

```
ØA> TOXENIX -B file1 ... fileN
```

All of the files mentioned on the command line will be transferred to the Altos 586. Each file will be saved in the current XENIX working directory, and will have the same name as the original file on the ACS 8000 system. Each character in a file will be displayed as it is sent except that the RETURN-LINEFEED at the end of each line will be converted to a single XENIX NEWLINE character before the file is sent. This prevents XENIX from converting each LINEFEED into an extra NEWLINE at the end of each line. Unfortunately, this causes the text to appear on the screen as if it were all on one line with no intervening carriage returns.

After all files from a command line are transferred you may continue to transfer additional files by issuing the appropriate command.

8. After all files have been transferred, enter the two character sequence "~." (i.e., curl, dot) at the beginning of a line, followed by a carriage-return. The message "Disconnected" will be displayed; it should then be followed by the normal XENIX prompt, indicating completion of the transfer.

In the unlikely event that the file being transferred contains the "~." sequence as the first 2 characters in a line, the transfer of the file will be terminated prematurely. "Disconnected" will be displayed at that point.

9. If the `-B` option has been used to transfer any binary files, each byte was encoded as two ASCII bytes before being sent. After you have completed your transfers and have exited from the File Transfer Program each binary file must be decoded by using the XENIX command:

```
$ /usr/bin/decode file1 ... fileN
```

NOTE

This utility is to be used only for ACS 8000 computers with XENIX Versions of 2.2d or higher, and for ALTOS 586 computers with XENIX Versions of 2.3 or higher.

The File Transfer Program, **FTP86**, resident on both MP/M master distribution diskettes, transfers files to a XENIX system from any two 8- or 16- bit Altos Computer System. The files are transferred through an asynchronous serial channel.

Description

FTP86 runs under the Multi-Program Monitor (MP/M-86) Operating System. Full error checking is provided through a CRC-16 polynomial. Correction is accomplished by re-transmission of data blocks.

FTP86 works only on the printer port. The link between computers can be made with a null modem cable or with two modems. (The null modem cable is a standard RS-232 cable that swaps lines 2 and 3 and 6 and 20.)

To transfer from MP/M or CP/M to XENIX, bring FTP86 up on the sending computer. The XENIX ftp program is brought up first on the receiving side. Be careful that files transmitted with FTP do not have the Read Only (RO) attribute. If the file is Read Only, FTP will not be able to write it on the receiving side. If an RO file is accidentally received, erase it on the receiving side, change the attribute to Read Write (RW) using the SET command under MP/M on the sending side, and transfer it again using FTP.

Baud Rates

Baud Rates are "selected" by running MPMSETUP.COM on 16-bit machines. Altos ACS-586 computers can run at 9600 baud on transmit and receive. ACS 8600 computers are limited to 1200 baud.

Step-by-Step Instructions

The receiving side is started by one of the following commands:

```
0C>FTP86
```

or

```
0C>FTP86 u:
```

re: "u:" is the drive letter of the destination disk. If no drive letter is specified, the logged disk is the destination disk.

following is displayed by the system:

```
File Transfer Program version 3.0  
Copyright (C) 1982 by Altos Computer Systems
```

Choose one of the port numbers below:

```
"6" for Altos 586 systems  
"8" for Altos 8600 systems
```

Enter your choice

The receiving FTP periodically types a "w" while waiting for the sender to become active. Since the receiving side normally does not exit by itself, enter <Control C> to get back to MP/M.

The sending side of the transfer is started by command:

```
0C>ftp [-f device] [-s speed] [name]
```

where:

```
-f device = the special file device that transfers files between machines. The default device is /dev/tty6, which uses port 6.
```

```
-s speed = transmission speed. Supported speeds are 1200, 2400, 4800, and 9600 bits per second. The default is 9600 baud.
```

```
[name] = directory, if other than home directory. For example, if you want to
```

transfer the file "update" to your directory "newdir," entry "newdir" as the name.

NOTES

- 1) Files sent from MP/M or CP/M systems to XENIX systems may contain extra spaces. If you enclose the entire filename in quotes, the UNIX shell recognizes it as the intended file name.
- 2) The File Transfer Program for MP/M is copyrighted by the Balcones Computer Corporation.

THE FILE TRANSFER UTILITY FOR XENIX-TO-XENIX

PROCEDURE C

The XENIX file transfer program, `ftp`, can transfer files between two Altos Computer Systems with the XENIX operating system.

Set Up Procedures

The ports for the devices on each machine should be connected via a null modem cable. (The null modem cable is a standard RS-232 cable that swaps lines 2 and 3, 4 and 5, and 6 and 20.) If the cable gets disconnected during transmission, wait for `ftp` to stop (takes up to a minute) before restarting on the same port. Otherwise, the first `ftp` interferes with the second.

The XENIX `ftp` utility defaults to the printer port (6). In order to use the printer and the `ftp` utility from the same port, either remove the printer cable or install a selector switch.

Note that the port on which `ftp` runs must have login disabled. Refer to the Configuring the Ports section in Chapter 7 for instructions on disabling ports.

Baud Rates

Altos 586 and ACS-8600 computers can run at 9600 baud on transmit and receive.

Step-by-Step Instructions

It does not matter which side, sending or receiving, is started first, as long as both sides are started within one minute of each other.

The `ftp` utility can be started by issuing the following command on the sending computer:

```
ftp [-f device] [-s speed] [name]
```

where:

`-f device` = the special file device that transfers files between machines. The default device is `/dev/tty6`, which uses port 6. The sending and receiving devices do not have to have the same port number.

`-s speed` = transmission speed. Supported speeds are 1200, 2400, 4800, and 9600 bits per second. The default is 9600 baud.

`name` = if sending -- the filename.
= if receiving -- not specified, unless you want the file received in a directory other than your current directory.

example, you may enter the command:

```
ftp -f /dev/tty5 -s 4800 newdir/newfile
```

which transfers the file named "newfile" on the sending XENIX system to the "newdir" directory already established on the receiving XENIX system.

The sending side outputs the character "s" every few seconds until communication is established with the other side.

The `ftp` utility is entered on the receiving computer:

```
ftp [-f device] [-s speed] [name]
```

where the device can differ, speed must be the same and the name is entered only if you want to specify a directory for the transferred file other than your

home directory. The receiving side outputs the character "w" every few seconds. During the file transfer, the ftp utility outputs an "*" after each successful transfer of 128-byte block increments. A "?" is returned each time a block is retransmitted to overcome a transmission error. If you receive many "'s," decrease the baud rate.

THE FILE TRANSFER UTILITY FOR XENIX-TO-MP/M

PROCEDURE D

The XENIX file transfer program, ftp, can transfer files from a XENIX system to an MP/M system.

Description

Since ftp is compatible with the file transfer utility for MP/M-86, files can be transferred between XENIX systems and the MP/M or CP/M systems. The XENIX ftp runs on the XENIX system, and the FTP86 runs on the MP/M system during file transfer between XENIX and MP/M. Files sent to MP/M and CP/M systems must have file names that are legal on those systems.

Set Up Procedures

The ports for the devices on each machine should be connected via a null modem cable. (The null modem cable is a standard RS-232 cable that swaps lines 2 and 3, 4 and 5, and 6 and 20.) If the cable gets disconnected during transmission, wait for ftp to stop (takes up to a minute) before restarting on the same port. Otherwise, the first ftp interferes with the second.

FTP86 for transferring MP/M runs only on the printer port 8 for the ACS 8600 and port 6 for the 586. The XENIX ftp utility defaults to the printer port (6). In order to use the printer and the ftp utility from the same port, either remove the printer cable or install a selector switch.

Note that the port on which ftp runs must have login disabled. Refer to the Configuring the Ports section in Chapter 7 for instructions on disabling ports.

Baud Rates

Altos ACS-586 computers can run at 9600 baud on transmit and receive.

Step-by-Step Instructions

It does not matter which side, sending or receiving, is started first, as long as both sides are started within one minute of each other.

Start the ftp utility by issuing the following command on the sending system:

```
ftp [-f device] [-s speed] [name]
```

where:

```
-f device = the special file device that transfers
            files between machines. The default
            device is /dev/tty6, which uses port
            6.

-s speed  = transmission speed. Supported speed
            are 1200, 2400, 4800, and 9600 bits
            per second. The default is 9600 baud.

name      = if sending -- the filename.
            = if receiving -- not specified, unless
            you want the file received in a direc-
            tory other than your home directory.
```

For example, you may enter the command:

```
ftp -f /dev/tty5 -s 4800 SAMPLE.TXT
```

which transfers a file named SAMPLE.TXT to the MP/M system. The sending side outputs the character "s" every few seconds until communication is established with the other side.

The FTP86 utility must be entered on the receiving MP/M system. The receiving side is started by one of the following commands:

```
ØC>FTP86
```

or

```
ØC>FTP86 u:
```

where: "u:" is the drive letter of the destination disk. If no drive letter is specified, the logged disk is the destination disk.

The following is displayed by the system:

```
File Transfer Program version 3.0
Copyright (C) 1982 by Altos Computer Systems

Choose one of the port numbers below:
    "6" for Altos 586 systems
    "8" for Altos 8600 systems

Enter your choice
```

The receiving FTP periodically types a "w" while waiting for the sender to become active. Since the receiving side normally does not exit by itself, enter <Control C> to get back to MP/M. The receiving side outputs the character "w" every few seconds. During the file transfer, the ftp utility outputs an "*" after each successful transfer of 128-byte block increments. A "?" is returned each time a block is retransmitted to overcome a transmission error. If you receive many "?s," decrease the baud rate.

NOTE

The File Transfer Program for MP/M is copyrighted by the Balcones Computer Corporation.

These definitions are provided for convenience. They explain terms and concepts that will help in understanding the information given in this manual. They are not meant to replace the full definitions given in the Glossary of the **Altos Operator's Guide**. Also, refer to **A User Guide to the UNIX System**, by Thomas and Yates, for a more complete UNIX glossary.

ABS -- Altos Business Solution

A software package offered by ALTOS, based on the Business Shell, which includes several application programs. A full list is given in the introduction.

ABS Menu Shell

An optional set of menus (called the Master Control Services menus), which are included when the ABS or other application packages are purchased. It is used to access the business XENIX services, the ABS or other software packages, and other services such as installing the software packages. See also Business Shell and Shell.

Administrator

This term has special meaning in the Business Shell. The "administrator" is allowed to do special functions that can affect all users, and has access to more information than regular users. Also called the System Administrator. See also Super-User.

Application Programs

Programs that provide word processing, or do accounting, or do "data base" services for information retrieval and reporting, are all grouped under the general name "application programs." Compare with Operating System.

Booting

A process that enables the computer to start operations.

Business Shell

A set of menus, with accompanying tutorial and help information, used to control the computer system and direct it in the tasks you wish done. See also Shell and ABS Menu Shell.

Command

Set of predefined statements that enable you to interface with the operating system via the command language (XENIX Shell).

Command Format

Each command has three parts:

- a keyword (the name of the XENIX command or program)
- a list of values or instructions (arguments)
- a terminating character (you press the Return key).

Command Language

Enables you to communicate with the operating system. The UNIX Shell is the command language for XENIX. See Shell.

Console

One of the terminals for using the computer system. The terminal connected to serial port 1 is the console, and has certain system control privileges not available from other terminals. In particular, the system can only be started up or shut down from the Console.

Control Character

The XENIX operating system provides control capabilities through control characters. For example, <Control-D> logs you off the system.

Directory

A catalog of files, organized by owners. The system has its files, each user has a collection of files, and some collections are shared among users. Each collection has a directory, and the system keeps a

directory of library information about all these files, where they are, who can use them, and how they can be used.

Editor

A program that enables you to create, view, and modify files.

File

A collection of information. In this manual, generally refers to files kept on the hard disk. See also Directory.

File Attributes

All files have attributes assigned to them, that control who may read the file or change it or delete it and give various other details about the organization and use of the files. For example, a user might allow others to read a file but not allow anyone else to change or delete it.

Kernel

Inner portion of an operating system which handles peripheral devices and basic functions. Not seen by the user, except in its effects.

Logging Off

Ending your individual session. Called "Quit" in the Business Shell and the ABS Menu Shell. See Logging On.

Logging On

Identifying yourself to the XENIX system so you can use it and can access your own files. User "logging" allows the system to protect your information from use by others. See also Password, Logging Off.

Operating System

An operating system, such as XENIX, supplies services to application programs. The services include sending information to peripheral devices and receiving information from them. ("Peripheral devices" refers to terminals, disk storage, printers, etc.) The operating system also provides general coordination for the users, and library services for keeping track of files. Compare with Application Programs.

Password

A secret word chosen by the user, which is then required by the system before it will allow access to that user's files.

Peripheral Devices

A general term for equipment attached to the central computer in a computer system, and used for input, output, and storage of information. For example, terminals, disk storage, printers, magnetic tape drives.

Process

An operating system's basic unit of execution.

Prompt, Prompt Character

The prompt character shows that XENIX is available to perform the tasks you request. Different shells have different prompts:

```
#   UNIX Shell, Super-User status
$   UNIX Shell, user status
```

Quit

End your individual session in the Business Shell or the ABS Menu Shell; equivalent to logging out or <Control-D> in the UNIX Shell.

Restoring Files

Reading a backup copy of a file back into the computer system. See Saving Files.

Saving Files

Making a copy of a file for backup, to use in case something happens to the original. See Restoring Files.

Shell

The outer portion of the operating system; what the user works with. XENIX has more than one shell. See Business Shell and the ABS Menu Shell.

Shutting Down

Shutting down the computer system should be done in such a way that others using it can finish properly before the system actually quits. Must be performed from the Console (port 1). See Console, Starting Up.

Starting Up

Starting up the computer system for general use by several users. Can only be done from the Console. See Console, Shutting Down.

Super-User

In XENIX, the "Super-User" performs special functions that can affect all users, and has access to more information than regular users. Super-User status should be used with caution. See System Administrator.

System Administrator

The System Administrator or Super-User, is responsible for system maintenance and efficiency. See Super-User.

System Prompt

A prompt is displayed when XENIX is ready to accept terminal input. The prompt varies depending on whether you are a regular user or a super-user, and depending on the shell you are in.

Terminal

Used for working with the computer system. Has a display screen and a keyboard. See also Console and Peripheral Devices.

UNIX

An operating system developed by Bell Laboratories, originally used on larger computers and now on micro-computers. See also XENIX.

Utilities

Useful programs that provide particular services for users of the computer system, such as programs for backing up and restoring files, or programs for formatting text files on a printer. The difference between an application program and a utility program is that a utility program provides services pertaining to using the computer system, while an application program makes use of the computer system to provide some service, such as accounting.

XENIX

A version of the UNIX operating system for small business computers (16-bit microcomputer systems). Because of the growth in capabilities of these computer systems, XENIX is not substantially different than UNIX.

